

# SKIN AND SCUBA DIVING EQUIPMENT



1964



CORONADO SUIT NORKEL TANK  
WEIGHT BELT CRESSI RONDINE FINS  
STABILIZER MASK VALVES  
FIXE PALME SINGLE CONTOUR SCUBA PAK  
SPEAR FISHING GUN SCUBA VEST  
SCUBA AIR REGULATOR DEPTH GAUGES  
SPEAR HEADS AND ACCESSORIES



**SALES ORGANIZATION 4**

---

**DIVE MASKS 5-7**

---

**SNORKELS 8**

---

**RONDINE FINS 9-11**

---

**UNDERWATER EXPOSURE SUITS 12-13**

---

**REGULATORS 14-18**

---

**TANK ASSEMBLIES 19**

---

**SCUBAPAK HARNESES 20**

---

**PROFESSIONAL TANK VALVES 21**

---

**TANK ACCESSORIES 22**

---

**SPEARFISHING GUNS 23-24**

---

**SPEARHEADS AND ACCESSORIES 25**

---

**DIVING ACCESSORIES 26-27**

---

**DIVING SAFETY SECTION 28-30**



## SNORKEL

A combination of rigid and flexible pipe snorkels with comfortable contoured mouthpieces.

## MASK

The finest rubber and Neoprene compounds. Tempered glass safety lens—stainless steel “Lens-Lock” band—feather edge seal.

## REGULATOR

Scubair Regulators. Professional engineering, simplicity, maximum air flow, provide minimum inhalation effort at any depth. Heavy chrome plated brass construction.

## VALVE

Professional tank valves specifically designed for divers—heavy forged brass—high pressure gauge outlet—low contour—easy action wheel—blowout proof “O” ring seal.

## TANK

All Healthways tanks have durable galvanized finish. They are also available with the exclusive black vinyl coating over galvanizing.

## SUIT

Custom contoured fit with the seams permanently bonded by Healthways exclusive process.

## WEIGHT BELT

Heavy duty two inch nylon webbing—stainless steel quick release buckle—non-slip contour weights.

## AUTOMATIC DECOMPRESSION METER

A simple guide to diving safety. Automatically calculates required decompression time.

## KNIFE

All purpose utility knife can be used to cut, hack, saw or even pry Abalones.

## FIXE PALME

Insures maximum fin security.

## RONDINE FINS

The most popular fin in the world. Maximum propulsion and comfort with minimum exertion.

# SALES ORGANIZATION



## LOS ANGELES GENERAL OFFICE

**DONALD M. BRESLOW**  
PRESIDENT  
P. O. Box 61061  
Los Angeles 61, Calif.  
Phone: 321-8110

**CHARLES R. VICTORY**  
CUST. SERV. & ADV. MGR.  
P. O. Box 61061  
Los Angeles 61, Calif.  
Phone: 321-8110

**JOHN GRAFFIN**  
MGR. EXPORT DEPT.  
P. O. Box 61061  
Los Angeles 61, Calif.  
Phone: 321-8110

**CLAUDE O'HAVER**  
PRODUCTION MGR.  
P. O. Box 61061  
Los Angeles 61, Calif.  
Phone: 321-8110

## WESTERN REGION

**ROBERT MOSS**  
P.O. Box 61061  
Los Angeles 61, Calif.  
Phone: 321-8110  
Calif., Nevada

**RAY EGNER**  
18468 N.E. 24th St.  
Bellevue, Wash.  
Phone: TUcker 5-1715  
N. Calif., Ore., Wash.,  
Mont., Ida., S.W. Canada

**JOEL SHERMAN**  
P.O. Box 61061  
Los Angeles 61, Calif.  
Phone: 321-8110  
Metropolitan  
Los Angeles

**ROBERT CARROLL**  
P.O. Box 61061  
Los Angeles 61, Calif.  
Phone: 321-8110  
Metropolitan  
Los Angeles

**C. W. McNUTT**  
6649 Vigo Drive  
San Diego 15, Calif.  
Phone: HOpkins 9-1787  
So. Calif., Ariz.,  
Utah, Wyo., Colo., N.M.

**ROBERT B. WEBER**  
695 Grandview Ave.  
San Fran., Calif.  
Phone: AT 5-3753  
Central Calif.  
Nevada

**D. MELVILLE CARR**  
1206 Waimanu Street  
Honolulu 14, Hawaii  
Phone: 50-2797  
Pacific  
Islands

## MIDWEST REGION

**STEVE HOFFMAN**  
7751 Davis Street  
Morton Grove, Ill.  
Phone: 965-5902  
Ill., Ind., Ky.  
So. Mich.

**FRANK BROWN**  
4904 Welford Drive  
Bellaire, Tex.  
Phone: Madison 3-8236  
Tex., Okla.  
Ark., Miss., La.

**DOUGLAS BUTCHART**  
618 Acme Street  
Green Bay, Wisc.  
Phone: HE 2-8389  
Wisc., Minn., S. D.  
N. D., Upper Mich.

**ROBERT KAYE**  
87 Emma Place  
Saddle Brook, N. J.  
Phone: DI 2-8872  
Ohio, Western Pa.  
West Va., Western Va.

**LEE ATCHISON**  
12806 E. 39th Terr.  
Independence, Mo.  
Phone: Clifton 4-7310  
Kan., Neb., Iowa, Mo.

## EASTERN REGION

**STAN ARMUS**  
160 Earl Place  
East Meadow, L.I., N.Y.  
Phone: PErshing 1-7736  
Metropolitan N.Y., N.J.  
Eastern Penn., Wash. D.C.  
Del., Md., Eastern Va.

**RICHARD HARDIN**  
53 Oxbow Road  
Needham, Mass.  
Phone: 444-0641  
N.Y., Conn., R.I.  
Mass., Vt., New Hamp.  
Maine

**CHARLES MILLER, SR.**  
670 Glen Forrest Rd., N.E.  
Atlanta 5, Ga.  
Phone: 255-6157  
Fla., Ga., Ala.  
S. C., N. C., Tenn.

## STABILIZATOR

catalog no. 1260  
 color professional black  
 price \$5.95

The world's most popular mask incorporates finger wells for pressure compensation of the ears. The Stabilizator Mask features stainless steel "Lens-Lock" band—tempered glass lens—split head strap for secure fit—comfortable feather edge seal. The Stabilizator "Clear-Ease" incorporates Healthways simple and efficient non-return valve which allows the diver to clear water from the mask in a normal swimming position.

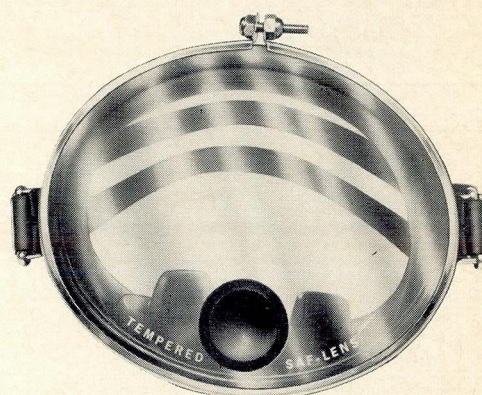

## STABILIZATOR "CLEAR-EASE"

catalog no. 1261  
 color professional black  
 price \$6.95

## PINOCCHIO PROFESSIONAL

catalog no. 1243 ✕  
 color professional black neoprene  
 price \$8.95

The exclusive nose design makes the Pinocchio the ultimate in pressure compensating masks. Accepted and used by the world's leading professional and sport divers. Minimum air displacement will allow up to 25% greater skin diving depth. The double feather edge provides a comfortable and absolute, leak-proof seal. The Pinocchio Professional features molded Neoprene for resistance to oil, wear, salt water and the elements—tempered glass lens—chrome plated "Lens-Lock" band—split headstrap for secure fit. The Pinocchio "Clear-Ease" incorporates the Cressi non-return valve which provides simple and efficient clearing of the mask.

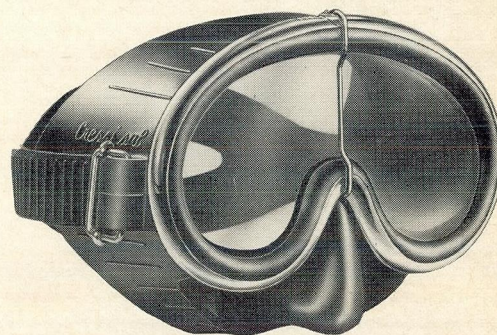

## PINOCCHIO "CLEAR-EASE"

catalog no. 1244  
 color professional black neoprene  
 price \$10.95

# DIVE MASKS



COMPENSATOR

#1223 5.95 (3.60)

#1252 4.95 (3.00)

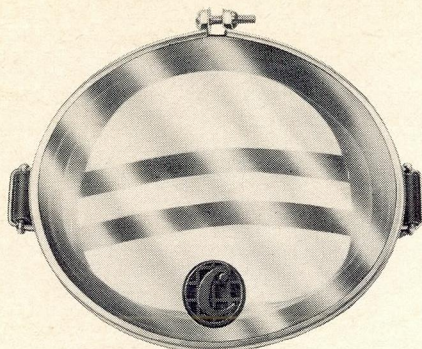

## PANORAMIQUE "CLEAR-EASE"

catalog no. 1224  
color french blue  
price \$5.95

The exclusive design of the Panoramique "Wide-Angle," the world's most popular mask, brings the lens closer to the eyes at a slant that offers undistorted vision over a wider range. The Panoramique Mask features tempered glass lens—stainless steel "Lens-Lock" band—split headstrap for secure fit—comfortable feather edge seal. The Panoramique "Clear-Ease" incorporates the Cressi non-return valve which allows the diver to clear water from the mask in a normal swimming position.



## PANORAMIQUE

catalog no.	1222	1272
color	french blue	professional black
price	\$4.95	\$4.95



## ESPADON

catalog no. 1220 ✕  
color french blue  
price \$3.95

The Espadon Dive Mask is a high quality, lightweight professional mask designed primarily for smaller faces. The Espadon features tempered glass lens—stainless steel "Lens-Lock" band—split headstrap for secure fit—comfortable feather edge seal.

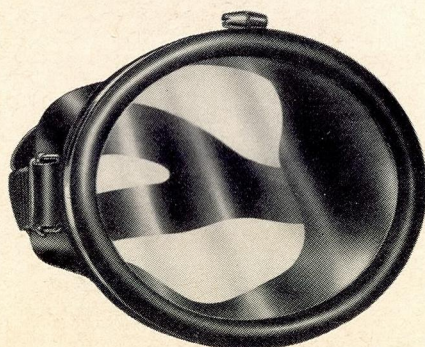

## CRESSI STAR

catalog no. 1228  
color blue  
price \$2.95

The Cressi Star is a high quality lightweight mask that features stainless steel "Lens-Lock" band—safety lens—split headstrap for secure fit—comfortable feather edge seal. The best value at this price.



## DIVE MASKS

### SQUALE

catalog no. 1225  
color professional black  
price \$4.95

The famous Squale Mask is now made of a special black rubber compound. The Squale Mask features stainless steel "Lens-Lock" band, tempered glass safety lens and a superb feather edge seal. The Squale "Clear-Ease" incorporates Healthways simple and efficient non-return valve which allows the diver to clear water from the mask in a normal swimming position.

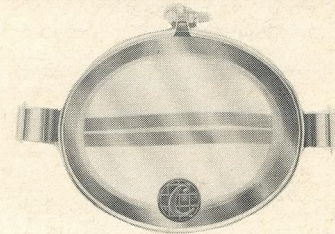
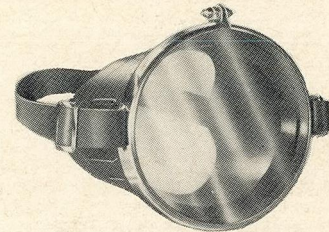

### SQUALE "CLEAR-EASE"

catalog no. 1226  
color professional black  
price \$5.95

### OSTRICA JR.

catalog no. 1239  
color blue  
price \$3.95

The only professionally designed, high quality mask for smaller faces. The Ostrica masks feature tempered glass lens—stainless steel "Lens-Lock" band—comfortable feather edge seal—split headstrap for secure fit.



### OSTRICA BANTAM

catalog no. 1240  
color blue  
price \$3.50

### AQUA CHAMP SPECIAL

catalog no. 1201  
color blue  
price \$1.25

This well-fitting junior mask is molded of high quality rubber with Healthways exclusive "bend edge" design and clear Styrene lens.

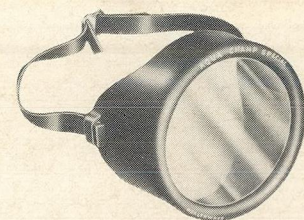

### AQUA PRO GOGGLES

catalog no. 1107  
color blue  
price \$2.95

These famous Goggles are designed for maximum safety and feature quality rubber compound—tempered glass lens—feather edge seal.

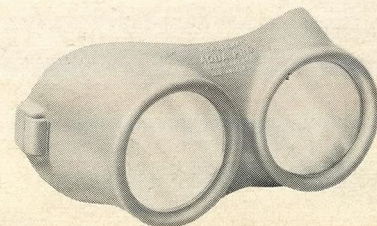

# SNORKELS



The snorkel, used primarily by skin divers, is also an important safety device to the Scuba Diver who surfaces with an empty tank. It enables him to breathe normally during that "long swim back to the boat."



## BELLO-PURGE

catalog no. 1435  
color professional black  
price \$3.95

The Bello-Purge Snorkel has all the advantages of the conventional flexible snorkel plus the added features of the exclusive "right angle" mouthpiece design for less drag, and purging valve positioned so that annoying residual water is purged with each exhalation. Made of a Neoprene and Virgin Gum rubber compound for lasting "flex" and durability.

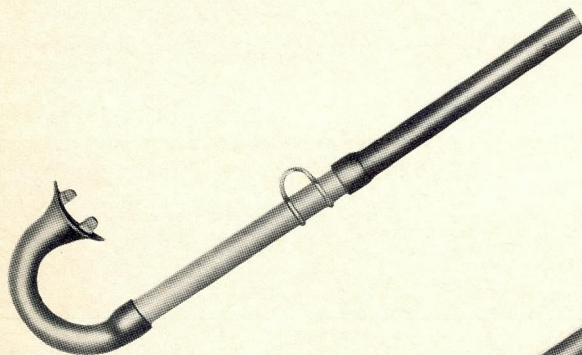

## GRESSI DELFINO

catalog no. 1430  
color blue  
price \$1.95

The snorkel preferred by professionals. The Cressi Delfino is made of a one-piece rubber elbow and mouthpiece with a rigid plastic center pipe and a flexible upper section of gum rubber.

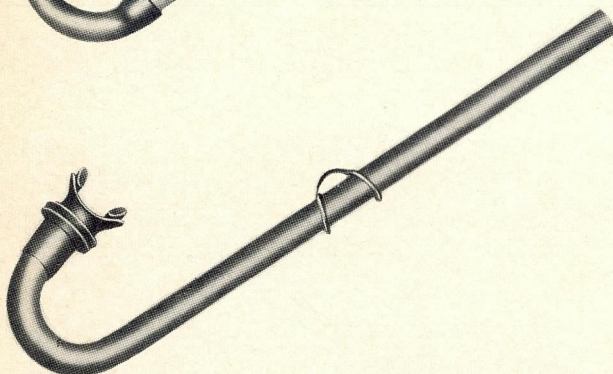

## GRESSI HAITI PROFESSIONAL

catalog no. 1432  
color professional black  
price \$1.95

The choice of professional divers in both style and construction. The Haiti Professional is made of the finest quality black rubber combined with a soft, flexible, accordion mouth piece.

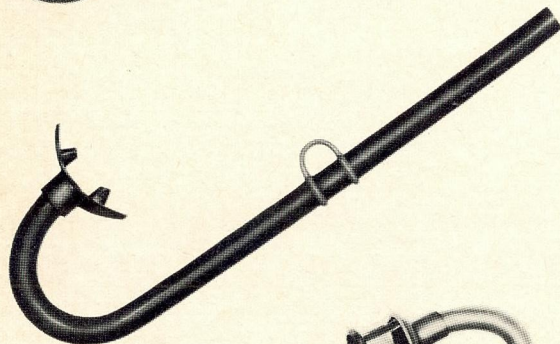

## SEA SCOUT

catalog no. 1403  
color assorted  
price \$1.00

A straight professional type snorkel of durable Polyethelene with a soft vinyl mouthpiece.

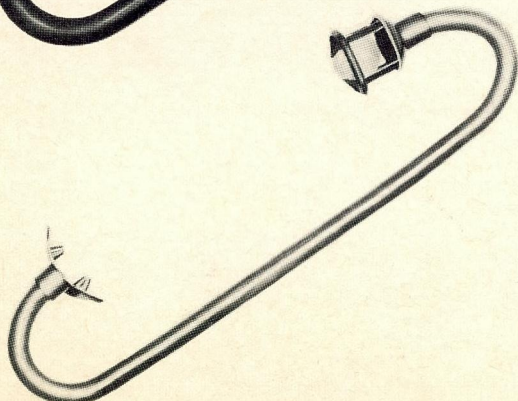

## SEA DIVE STANDARD

catalog no. 1405  
color assorted  
price \$1.25

A popular snorkel with a soft vinyl mouthpiece and "check ball" cage.



Why **RONDINE FINS** outsell all others five to one. Created by Cressi, the most renowned manufacturer of underwater sports equipment. The Rondine Fins have achieved worldwide acceptance as the finest in design, construction, fit and performance. The scientifically designed Cressi Rondine is the most copied (but never duplicated) fin in the entire history of underwater sports.

Only the Cressi Rondine offers these outstanding features: Blade angle which provides maximum thrust with minimum effort. The original full foot, open toe design which assures a comfortable fit. The sizes increase in width as well as length in the proper proportions. Light weight—less bulk. Specially integrated rubber compounds assure comfortable fit and efficient blade action.

### COMPETITION

catalog no.	<b>1395</b>	<b>1396</b>	<b>1397</b>	<b>1398</b>
color	<b>black</b>	<b>black</b>	<b>black</b>	<b>black</b>
size	<b>7-9</b>	<b>9-11</b>	<b>11-13</b>	<b>13-16</b>
price	<b>\$13.95</b>	<b>\$13.95</b>	<b>\$13.95</b>	<b>\$13.95</b>

The fin of world champions. Designed for maximum comfort, propulsion and durability. Used by Underwater Demolition Teams throughout the world and by leading professional and sport divers. Made of a combination of rubber textures which provide the famous foot comfort and fin tip rigidity desired by the experienced diver. Now equipped with the Fixe Palme universal strap for absolute fin security under the most turbulent conditions.

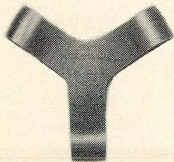

FIXE PALME UNIVERSAL STRAP

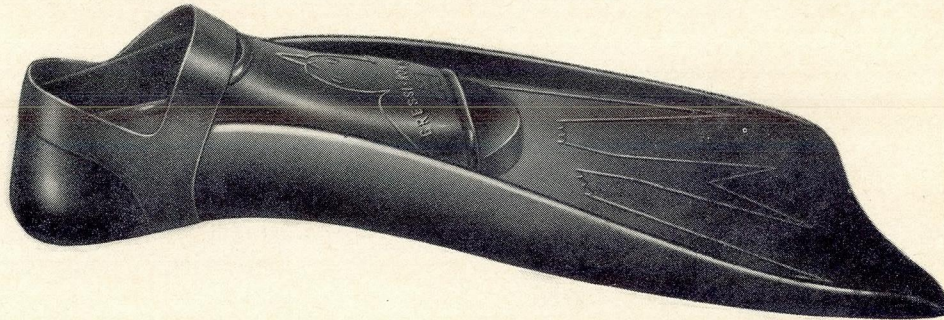

U.S. Patent No. 2737668

### SUPER RONDINE

catalog no.	<b>1390</b>	<b>1391</b>	<b>1392</b>	<b>1393</b>
color	<b>blue</b>	<b>blue</b>	<b>blue</b>	<b>blue</b>
size	<b>5-7</b>	<b>7-9</b>	<b>9-11</b>	<b>11-13</b>
price	<b>\$13.95</b>	<b>\$13.95</b>	<b>\$13.95</b>	<b>\$13.95</b>

The missing link in underwater propulsion—greater propulsion with less effort. From the creator of the world's finest underwater sports equipment comes the all new Super Rondine fin to add a new dimension in underwater propulsion. The Super Rondine fin transforms the usual negative blade area, common to all fins, into a positive thrust area, creating continuous propulsion on the downward as well as the upward thrust. This extra propulsion is obtained by two blade vents covered by a hinged flap, which shuts automatically on the upward thrust and opens on the downward thrust. As a result of this innovation the Super Rondine fin provides increased propulsion with less effort.

HINGED FLAP

BLADE VENT

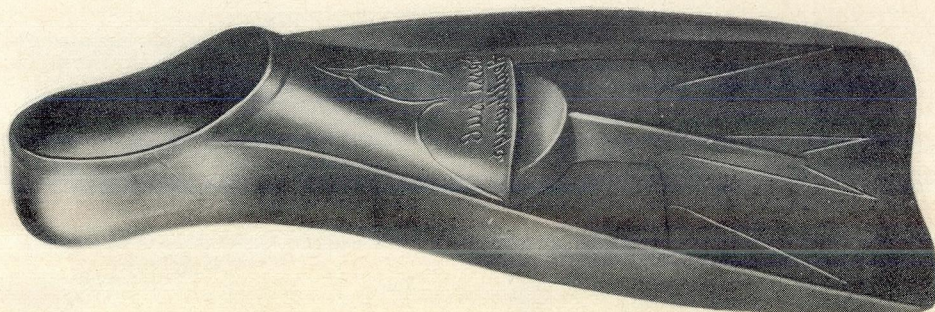
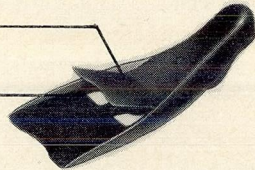

U.S. Patent No. 2737668

# RONDINE FINS



## GENOA PROFESSIONAL

catalog no.	1330	1331	1332	1333	1336
color	black	black	black	black	black
size	5-7	7-9	9-11	11-13	13-16
price	\$10.95	\$10.95	\$10.95	\$10.95	\$10.95

The original black rubber fin that has become a world-wide leader in popularity. The Genoa Professional is designed to provide maximum propulsion from its fin tip and side rigidity and at same time offer form-fitting comfort.

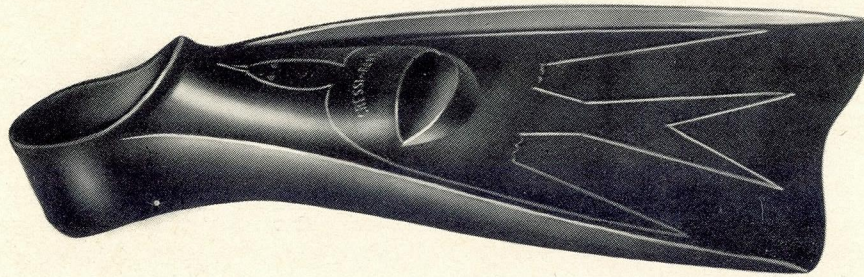

U.S. Patent No. 2737668

## CORMORANT

catalog no.	1340	1341	1342	1343
color	black	black	black	black
size	5-7	7-9	9-11	11-13
price	\$9.95	\$9.95	\$9.95	\$9.95

The Rondine Cormorant is made of a special black rubber compound that combines a rigid but light weight construction and provides maximum comfort and propulsion.

## MEDITERRANEAN

catalog no.	1350	1351	1352	1353	1354
color	blue	blue	blue	blue	BWE
size	5-7	7-9	9-11	11-13	13-16
price	\$11.50	\$11.50	\$11.50	\$11.50	13.95 (8.40)

Made of floating rubber compound, the Rondine Mediterranean combines the comfort, fin tip rigidity and rugged light weight construction desired by all divers. Will not mark pool.

## GARIBALDI

catalog no.	1360	1361	1362	1363
color	yellow	yellow	yellow	yellow
size	5-7	7-9	9-11	11-13
price	\$12.50	\$12.50	\$12.50	\$12.50

The Rondine Garibaldi is made of a special floating, yellow rubber compound which allows easy identification. It has exceptionally light weight construction, comfort and fin tip rigidity. Will not mark pool.

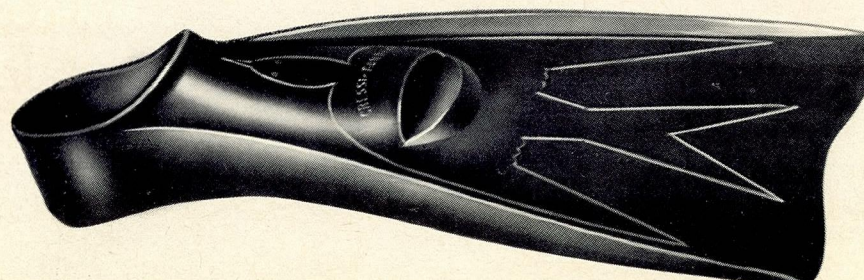

U.S. Patent No. 2737668



# Rondine Fins

## Rondine Junior

catalog no.	<b>1373</b>	<b>1374</b>	<b>1375</b>
color	<b>blue</b>	<b>blue</b>	<b>blue</b>
size	<b>2-3</b>	<b>3-4</b>	<b>4-5</b>
price	<b>\$5.95</b>	<b>\$5.95</b>	<b>\$5.95</b>

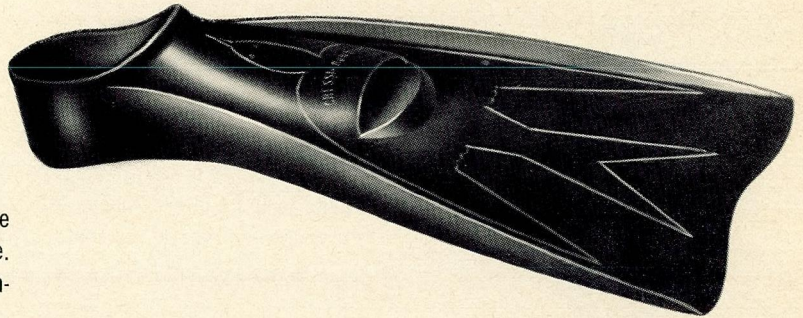

The Rondine Junior incorporates all the features of the professional Rondine fins, in sizes to fit young people. These floating lightweight fins are exceptionally comfortable. Will not mark pool.

## Rondine Adjustable

catalog no.	<b>1381</b>	<b>1382</b>	<b>1383</b>
color	<b>blue</b>	<b>blue</b>	<b>blue</b>
size	<b>1-5</b>	<b>5-10</b>	<b>10-14</b>
	<b>small</b>	<b>medium</b>	<b>large</b>
price	<b>\$5.95</b>	<b>\$5.95</b>	<b>\$5.95</b>

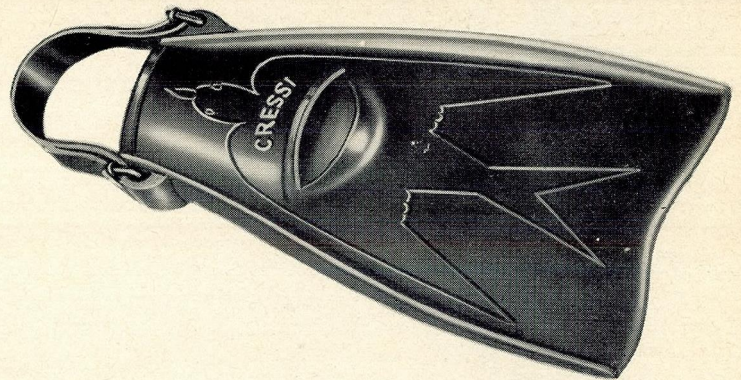

The Rondine Adjustable was created for the discriminating diver who prefers the adjustable open heel design. The comfortable contour strap and safety-lock buckle make this the finest adjustable fin in the world. Will not mark pool.

## Water Dogs

catalog no.	<b>1302</b>	<b>1303</b>	<b>1304</b>
color	<b>blue</b>	<b>blue</b>	<b>blue</b>
size	<b>up to 6</b>	<b>4-8</b>	<b>8-13</b>
price	<b>\$3.95</b>	<b>\$3.95</b>	<b>\$3.95</b>

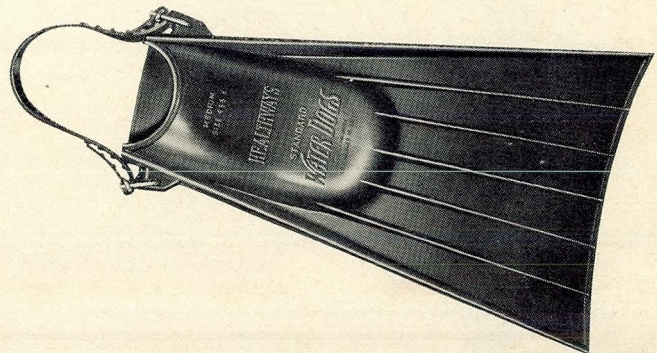

Healthways Water Dogs combine quality and professional design with exceptional durability and lightness. These all-around fins are molded of a special rubber compound and feature an adjustable strap and non-slip safety buckle. Will not mark pool.

## Fixe Palme

catalog no.	<b>1370</b>	<b>1371</b>
color	<b>black</b>	<b>black</b>
size	<b>7-11</b>	<b>9-16</b>
	<b>medium</b>	<b>large</b>
price	<b>\$1.95</b>	<b>\$1.95</b>

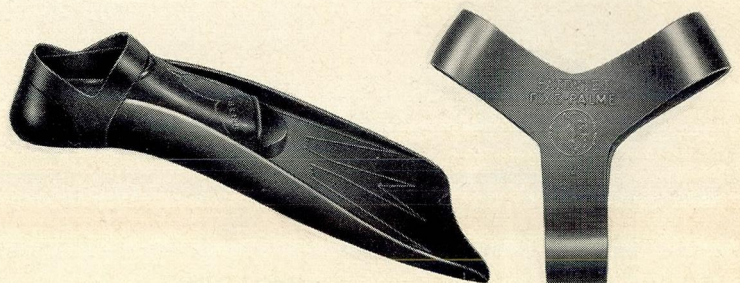

The universal Fixe Palme holds any closed heel fin to your foot under the most turbulent conditions. The Fixe Palme provides absolute fin security by holding the fin in three places—instep, arch and heel.

# UNDERWATER EXPOSURE SUITS



## CORONADO "NYLO-FOAM" NEOPRENE SUIT

2 piece suit made of 3/16" or 1/4" heavy duty, high stretch foam Neoprene with durable "four-way stretch" nylon lining for added strength and tear resistance. The Coronado "Nylo-Foam" suit features: Double duty snap-patch to reinforce suit at greatest stress point—cross seam at arm pit eliminated—heavy duty giant zipper on the shirt front.

3/16"	catalog no.	0521	0522	0523	0524
	size	small	medium	large	x-large
	price	\$53.50	\$53.50	\$53.50	\$53.50
1/4"	catalog no.	0526	0527	0528	0529
	size	small	medium	large	x-large
	price	\$58.50	\$58.50	\$58.50	\$58.50



## CORONADO DELUXE "NYLO-FOAM" NEOPRENE SUIT

2 Piece Suit made of 3/16" or 1/4" heavy duty, high stretch, double skin foam Neoprene with durable "four way stretch" nylon lining for added strength and tear resistance. The nylon is molded to the Neoprene by an exclusive process forming a permanent bond. Healthways Coronado Deluxe Suit features: stripping on the inside for maximum seam strength—heavy duty zipper in arms and legs and heavy duty giant zipper on shirt front.

3/16"	catalog no.	0541	0542	0543	0544
	size	small	medium	large	x-large
	price	\$67.95	\$67.95	\$67.95	\$67.95
1/4"	catalog no.	0546	0547	0548	0549
	size	small	medium	large	x-large
	price	\$74.95	\$74.95	\$74.95	\$74.95



## BALBOA AND AQUAFEMME NEOPRENE JACKETS

An ideal jacket for skin diver, surfer and water skier. Healthways form fitting jackets are made of 3/16" heavy duty, high stretch, double skin Neoprene with a heavy duty giant zipper.

BALBOA	catalog no.	0601	0602	0603	0604
	size	small	medium	large	x-large
	price	\$19.95	\$19.95	\$19.95	\$19.95
AQUAFEMME	catalog no.	0610	0611	0612	0613
	size	x-small	small	medium	large
	price	\$19.95	\$19.95	\$19.95	\$19.95



# SUIT ACCESSORIES

## "NYLO-FOAM" THERMO-VEST

An important addition to your Neoprene suit for cold water dives. The contoured Thermo-Vest offers a double thickness of protective insulation in the upper body where it is needed most. Made of 1/8" foam neoprene with "four way stretch" nylon lining.



catalog no.	<b>0620</b>	<b>0621</b>	<b>0622</b>
size	<b>small</b>	<b>medium</b>	<b>large</b>
price	<b>\$14.95</b>	<b>\$14.95</b>	<b>\$14.95</b>

## "NYLO-FOAM" HOOD

Made of 1/8" heavy duty foam Neoprene with "four way stretch" nylon lining on the inside. The extra long, contour design allows the hood to be worn inside the suit to form a tight seal and eliminate the exchange of water.



catalog no.	<b>0720</b>	<b>0721</b>	<b>0722</b>
size	<b>small</b>	<b>medium</b>	<b>large</b>
price	<b>\$5.75</b>	<b>\$5.75</b>	<b>\$5.75</b>

## "NYLO-FOAM" BOOTS

Made of 1/8" heavy duty foam Neoprene with "four way stretch" nylon lining. The inside lining allows the boots to be put on and removed easily.



catalog no.	<b>0710</b>	<b>0711</b>	<b>0712</b>	<b>0713</b>
shoe size	<b>5-7</b>	<b>7-9</b>	<b>9-11</b>	<b>11-14</b>
price	<b>\$8.25</b>	<b>\$8.25</b>	<b>\$8.25</b>	<b>\$8.25</b>

## GLOVES

Made of 3/16" heavy duty foam Neoprene. They provide maximum mobility and feature a heavy duty zipper for ease in putting on and removing gloves.



catalog no.	<b>0700</b>	<b>0701</b>	<b>0702</b>
size	<b>small</b>	<b>medium</b>	<b>large</b>
price	<b>\$6.25</b>	<b>\$6.25</b>	<b>\$6.25</b>

## BLACK MAGIC

catalog no.	<b>1798</b>
description	<b>foam neoprene cement</b>
price	<b>\$1.25</b>



## RUBBER DUST

catalog no.	<b>1791</b>
description	<b>concentrated powdered hydrous silicate of magnesium</b>
price	<b>\$ .60</b>



Healthways Decompression Table Decal gives you the maximum diving time at a given depth with no decompression and maximum diving time with decompression only at 10 feet. It can be attached easily to the arm of any Neoprene diving suit.

## DECOMPRESSION TABLE DECAL

catalog no.	<b>1719</b>
price	<b>\$1.00</b>

DEPTH IN FEET	TIME ON DIVE — IN MINUTES —		DECOMPRESSION — AT 10 FEET —	
	NO DECOMPRESSION	WITH DECOMPRESSION	NO DECOMPRESSION	WITH DECOMPRESSION
55	78	130	2	—
60	55	90	2	—
70	43	60	4	—
80	35	50	4	—
90	30	45	6	—
100	25	40	12	—
150	18	30	11	—
180	12	20	4	—
160	8	15	9	—
180	5	10	7	—
200	4	8	25	—

FOR DEPTH AND TIME EXCEEDING THIS TABLE USE  
HEALTHWAYS' DECOMPRESSION METER

## CORONADO NEOPRENE REPAIR KIT

catalog no.	<b>1794</b>	price	<b>\$2.50</b>
-------------	-------------	-------	---------------

## CORONADO "NYLO-FOAM" REPAIR KIT

catalog no.	<b>1795</b>	price	<b>\$2.50</b>
-------------	-------------	-------	---------------

## MEN'S SIZE CHART

	SMALL	MEDIUM	LARGE	X-LARGE
height	to 5'8"	to 5'11"	to 6'	to 6'3"
chest	32-35	35-38	38-40	40-43
waist	27-30	30-33	33-35	35-39

## WOMEN'S SIZE CHART

	X-SMALL	SMALL	MEDIUM	LARGE
bust	30-32	32-34	34-36	36-38
waist	18-22	20-24	22-26	26-30
hips	30-34	32-36	34-38	36-40
height	4'8"-5'2"	5'-5'6"	5'2"-5'8"	5'4"-5'11"

# SCUBAIR "300"



## THE WORLD'S MOST OUTSTANDING REGULATOR. THE SCUBAIR "300" INCORPORATES HEALTHWAYS UNIQUE SONIC ALARM DEVICE

**FIRST STAGE:** For the first time in the history of self-contained diving, a regulator features an audible alarm device indicating that the air supply in the tank has reached the minimum reserve level of 300 psi. Until all the air has been exhausted, the alarm device continues to operate. With each inhalation, the loud clicking reminds the diver he is breathing reserve air. WITH THE SCUBAIR "300" THERE IS NO POSSIBILITY OF FORGETTING THIS VERY IMPORTANT AND LIFE SAVING FACT. The minimum reserve pressure of 300 psi is approximately the same as in constant air reserve valves, but with the Scubair "300" there is no necessity of manually switching to reserve air. The Scubair "300" first stage features Healthways exclusive internal yoke screw which eliminates the conventional wing nut and provides an easily operated, snag proof means of attaching the regulator—high pressure plug for attaching the Submersible Gauge which enables the diver to know at all times how much air remains in the cylinder while diving—a removable low pressure plug which provides for the attachment of an additional second stage for training purposes. The Scubair "300" first stage is constructed of chrome plated forged brass, stainless steel springs and is impervious to the elements.

**SECOND STAGE:** A "downstream" demand mechanism is engineered into the Scubair "300" second stage to deliver more air than any diving regulator available. This downstream demand valve automatically serves as a safety relief valve in case of an over pressure in the air supply hose. The balanced Venturi system allows the diver to breathe comfortably at any depth with no increase in inhalation effort. The Scubair "300" second stage features double exhaust valves—contoured air exhaust to prevent bubbles from obstructing vision—recessed snag proof clearing button—nylon reinforced Neoprene diaphragm—"Quik-Klip" to facilitate inspection and maintenance—leak proof "O" ring seals for maximum safety—easy turning hose swivel—The Scubair "300" second stage is constructed of heavy gauge chrome plated brass, all stainless steel springs and is impervious to the elements.

## SCUBAIR '300'

catalog no. 1663  
description single-hose, two-stage regulator  
price \$69.95

U.S. Patent Nos. 195803, 3101732

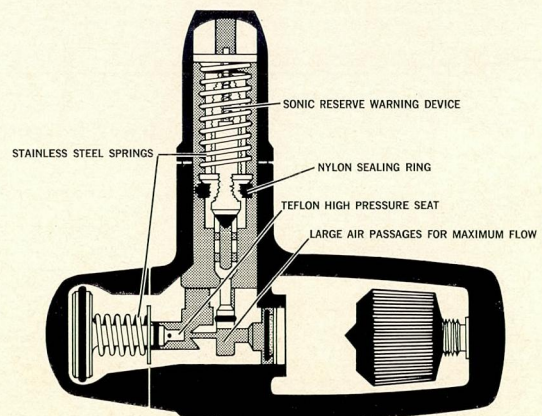



# SCUBAIR "J"

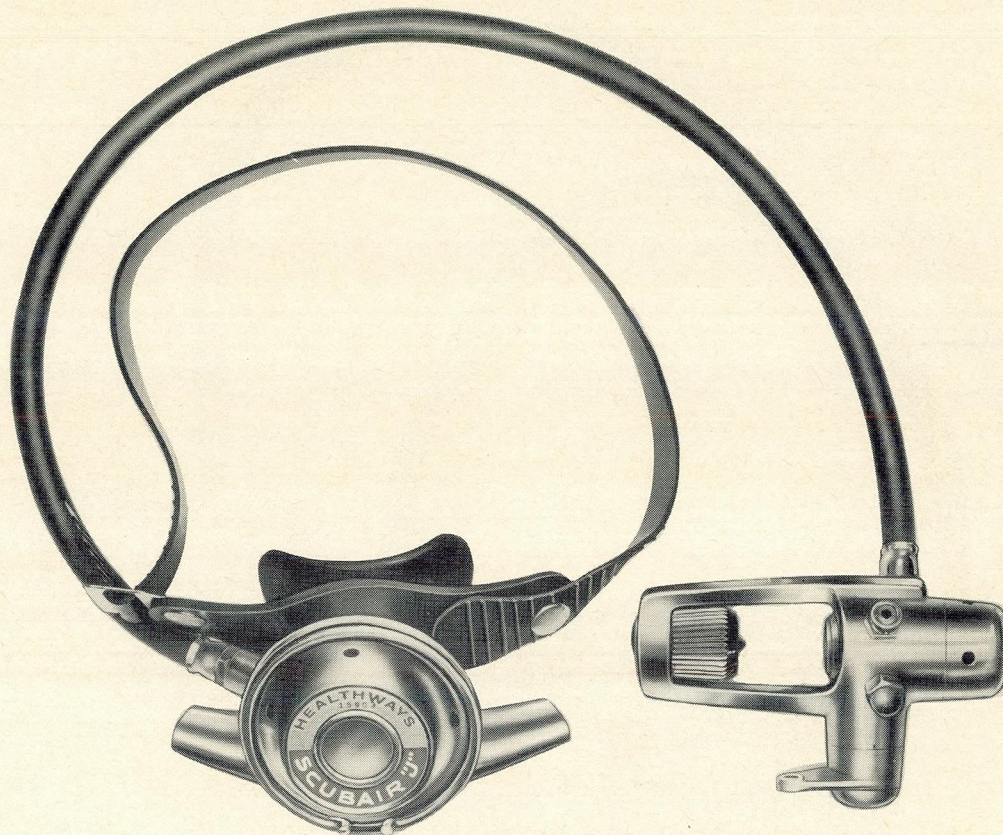

## A PROFESSIONALLY ENGINEERED REGULATOR INCORPORATING A BUILT-IN SPRING LOADED CONSTANT AIR RESERVE

**FIRST STAGE:** The Scubair "J" first stage incorporates a spring loaded constant air reserve mechanism. This mechanism provides the diver with a 300 psi constant air reserve even though his cylinders are not equipped with reserve valves. The Scubair "J" first stage features Healthways exclusive internal yoke screw which eliminates the conventional wing nut and provides as easily operated, snag proof means of attaching the regulator—a removable high pressure plug for attaching the Submersible Gauge that enables the diver to know at all times how much air remains in the cylinder while diving—a removable low pressure plug that provides for the attachment of an additional second stage for training purposes. The Scubair "J" first stage is constructed of chrome plated forged brass, all stainless steel springs and is impervious to the elements.

**SECOND STAGE:** A "downstream" demand mechanism is engineered into the Scubair "J" second stage to deliver more air than any diving regulator available. This downstream demand valve automatically serves as a safety relief valve in case of an over pressure in the air supply hose. The balanced Venturi system allows the diver to breathe comfortably at any depth with no increase in inhalation effort. The Scubair "J" second stage features double exhaust valves—contoured air exhaust to prevent bubbles from obstructing the vision—recessed snag proof clearing button—nylon reinforced Neoprene diaphragm—"Quik-Klip" to facilitate inspection and maintenance—leak proof "O" ring seals for maximum safety—easy turning hose swivel—The Scubair second stage is constructed of heavy gauge chrome plated brass, all stainless steel springs and is impervious to the elements.

## SCUBAIR 'J'

catalog no. 1662  
description single-hose, two-stage regulator  
(pull rod included)  
price \$59.95

U.S. Patent Nos. 195803, 3101732

## FIRST STAGE

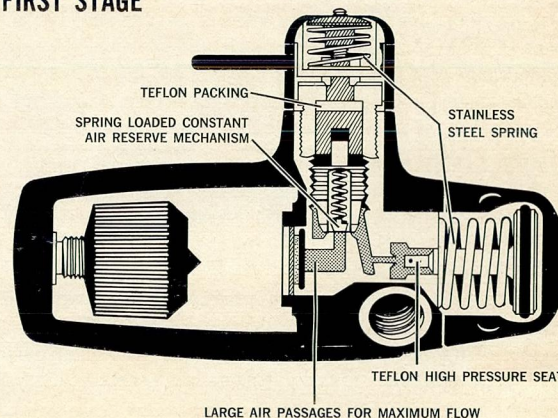

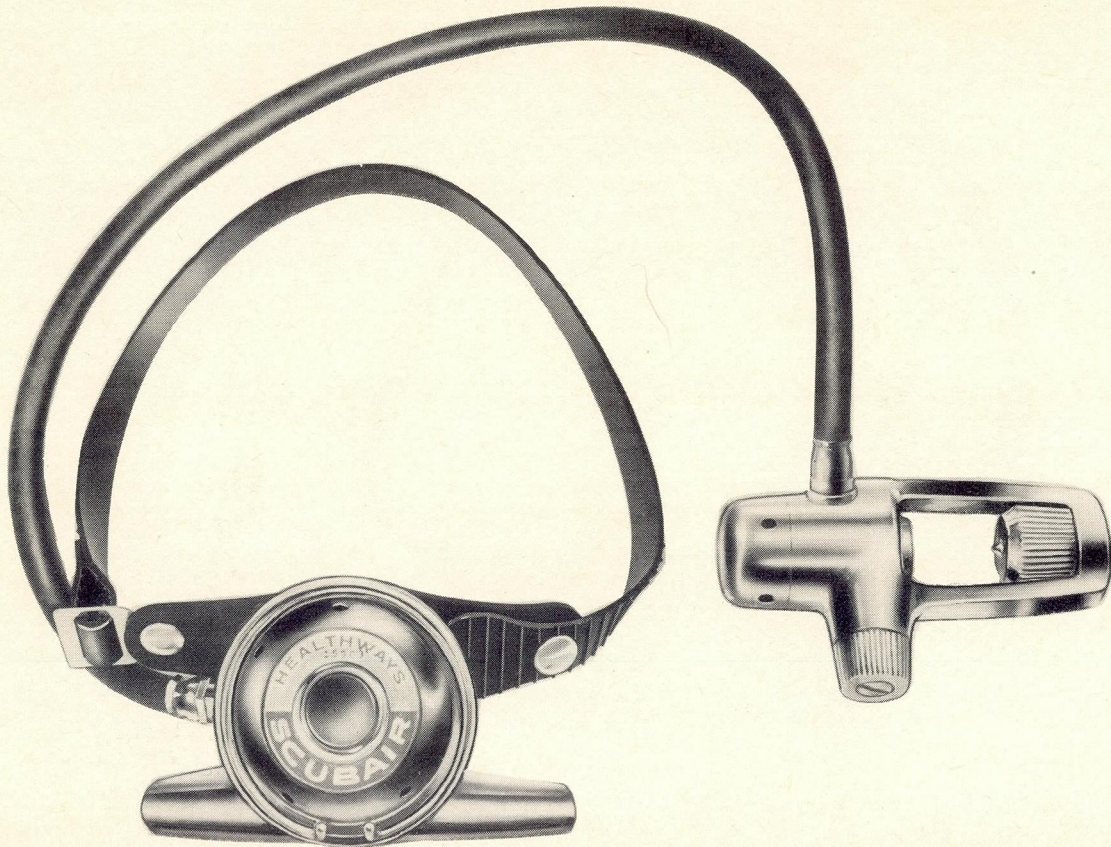

**THE MOST WIDELY ACCLAIMED REGULATOR IN THE HISTORY OF SELF-CONTAINED DIVING. THE REGULATOR THAT ESTABLISHED THE PROFESSIONAL CLASS IN SINGLE HOSE UNITS.**

**FIRST STAGE:** The Scubair first stage has the most efficient and functional design of any single hose regulator. It incorporates the foolproof "O" ring piston pressure reduction mechanism—only one moving part. A manually operated air reserve selector switch enables the diver to adjust his regulator to the automatic depth compensated "Auto Reserve" position or to the "J Valve" position, if the diver prefers to use the constant air reserve valve on his cylinder. Healthways exclusive internal yoke screw eliminates the conventional wing nut and provides an easily operated, snag proof means of attaching the regulator. Finger tip control is all that is necessary for a complete seal with the modern "O" ring valves. The Scubair first stage contains a high pressure plug which can be removed and the Submersible Gauge attached to enable the diver to know at all times how much air remains in the cylinder while diving. A removable low pressure plug provides for the attachment of an additional second stage for training purposes. The Scubair first stage is chrome plated forged brass, all stainless steel springs and impervious to the elements.

**SECOND STAGE:** A "downstream" demand mechanism is engineered into the Scubair second stage to deliver more air than any diving regulator available. This downstream demand valve automatically serves as a safety relief valve in case of an over pressure in the air supply hose. The balanced Venturi system allows the diver to breathe comfortably at any depth with no increase in inhalation effort. The Scubair second stage features double exhaust valves—contoured air exhaust to prevent bubbles from obstructing vision—recessed snag proof clearing button—nylon reinforced Neoprene diaphragm—"Quik-Klip" to facilitate inspection and maintenance—leak proof "O" ring seals for maximum safety—easy turning hose swivel—The Scubair second stage is heavy gauge chrome plated brass, all stainless steel springs and impervious to the elements.

## SCUBAIR

catalog no. 1665  
 description single-hose, two-stage regulator  
 price \$49.95

U.S. Patent Nos. 195803, 3101732

## FIRST STAGE

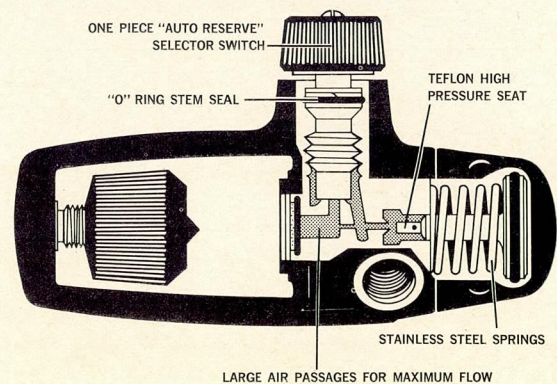





# SCUBA STAR

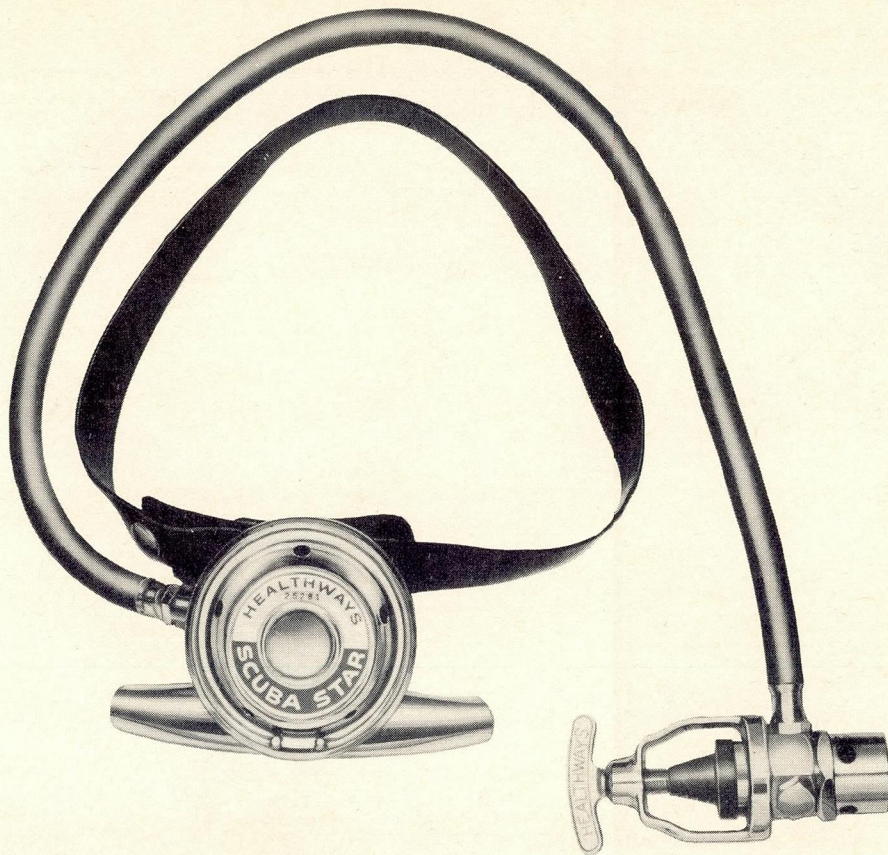

## THE WELL-PROVEN PIONEER OF "O" RING PISTON REGULATORS

The Scuba Star is not limited to "shallow water" or "sport diving," it is professionally designed and engineered to be used comfortably to depths of 200 feet.

**FIRST STAGE:** The Scuba Star first stage has only one moving part which makes it outstanding in function, simplicity and maintenance. A depth compensated automatic air reserve "K Restrictor" is assembled into the high pressure block, which can be replaced with the "J Restrictor" if the diver prefers to use a constant air reserve valve. A safety relief valve is incorporated into the first stage which eliminates the possibility of over pressurizing the regulator. The Scuba Star first stage features a high pressure plug which can be removed and the Submersible Gauge installed to enable the diver to know at all times how much air remains in the cylinder while diving. The first stage is machined from solid brass with a forged yoke and screw, and features a heavy chrome finish.

**SECOND STAGE:** The Scuba Star second stage features Healthways unique double exhaust valves, which assures the diver of an absolute dry air supply under all conditions. The one piece tilt valve demand mechanism provides the diver with easy breathing and offers foolproof simplicity. The Scuba Star second stage features contoured exhaust to prevent bubbles from obstructing vision—"Quik-Klip" to facilitate inspection and maintenance—snag proof clearing button to activate the demand valve—nylon reinforced Neoprene diaphragm with stainless steel diaphragm disc—leak proof "O" ring seals for maximum safety—easy turning hose swivel—high test nylon and Neoprene hose. The Scuba Star second stage is constructed of heavy gauge chrome plated brass, all stainless steel springs, and is impervious to the elements.

## SCUBA STAR

catalog no. 1664  
description single-hose, two-stage regulator  
price \$34.95

U.S. Patent No. 195803

## FIRST STAGE

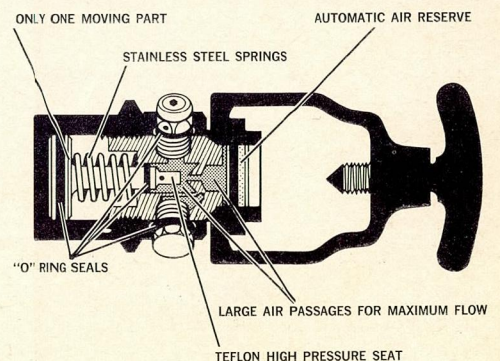

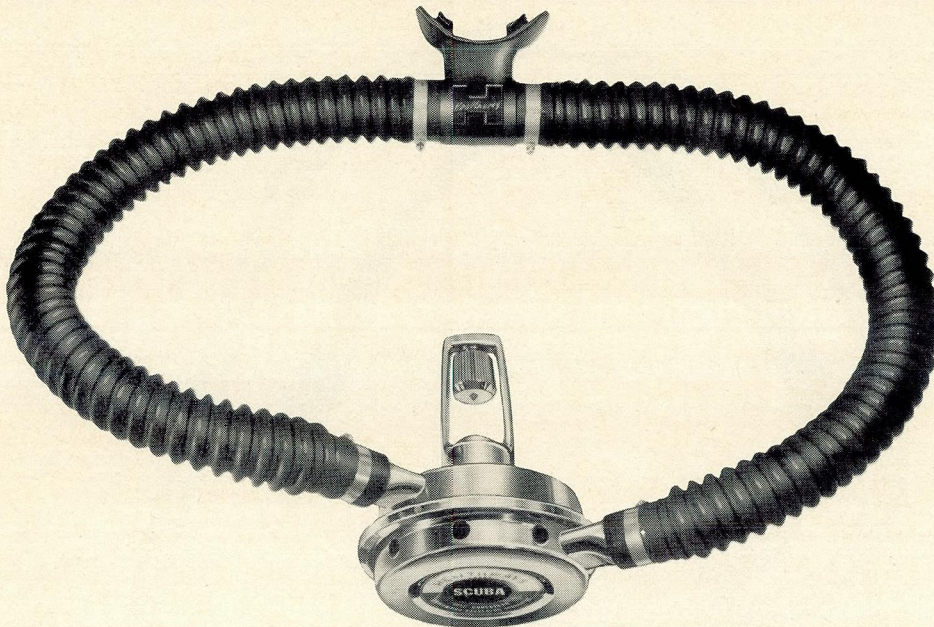

## SCUBA

catalog no. 1611  
 description **double hose, single stage regulator**  
 price **\$47.95**

U.S. Patent Nos. 195803, 3101732

**THE SCUBA IS THE MOST POPULAR AND DEPENDABLE REGULATOR IN ITS CLASS.** The Scuba incorporates a balanced Venturi system which provides the diver with effortless breathing at any depth. A Venturi air deflector in the mouthpiece prevents involuntary loss of air, common to other single stage Venturi regulators. The Scuba features a simple, efficient, single stage mechanism—pressure balanced exhaust valve for effortless exhalation—a safety non-return mouthpiece—durable Neoprene hose and mouthpiece assembly—Healthways exclusive internal yoke screw which eliminates the conventional wing nut and provides an easily operated snag proof means of attaching the regulator—nylon reinforced Neoprene diaphragm—heavy chrome plated brass and stainless steel construction.

## FIRST STAGE

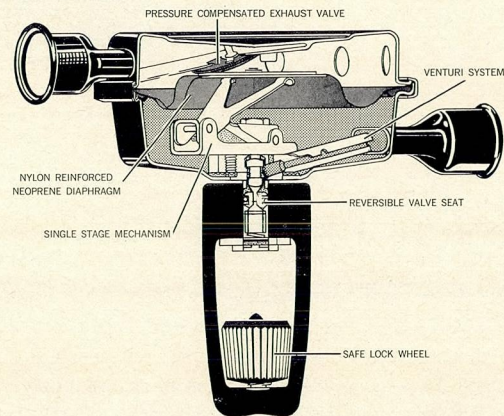

## UNCONDITIONAL TWO YEAR GUARANTEE

TWO YEAR UNCONDITIONAL GUARANTEE FOR 1964 HEALTHWAYS REGULATORS—THE SCUBA STAR, SCUBAIR, SCUBAIR "J," SCUBAIR "300" AND THE SCUBA

HEALTHWAYS IS THE ONLY MANUFACTURER OF SCUBA EQUIPMENT TO OFFER AN UNCONDITIONAL GUARANTEE AGAINST DEFECTS IN MATERIAL AND WORKMANSHIP FOR TWO YEARS FROM DATE OF PURCHASE. THIS TWO YEAR GUARANTEE IS THE PROOF OF THE SUPERIOR QUALITY OF HEALTHWAYS PRODUCTS. HEALTHWAYS SCUBA EQUIPMENT IS THE BEST THAT MONEY CAN BUY.



# TANK ASSEMBLIES

**Professional Tanks.** Healthways Professional Tanks are made from Alloy Steel as required by I.C.C. (Interstate Commerce Commission) specifications. Healthways uses a Chromium-molybdenum Steel, A.I.S.I. No. 4130, which provides the strength and other physical characteristics required by the I.C.C. There are three tests performed to prove the strength and ductility of the metal. Tensile, Crush and Hydrostatic. All cylinders are continually

checked to meet Healthways exacting requirements during the production cycle to ensure proper wall thickness, threads, interior and exterior conditions. All Healthways tanks are galvanized for lasting protection against salt water, exposure and rough handling. Healthways Black Vinyl Tanks are first galvanized for double protection.

## 80 CU. FT. TANK ASSEMBLIES

	catalog no. 0210		
	includes	No. 0120 80 Cu. Ft. Galvanized Tank 3/4" "O" Ring Straight Pipe Thread	No. 1642 High Pressure Valve
	price	\$53.45	
<hr/>			
catalog no.	0120	catalog no.	0200
includes	80 Cu. Ft. Tank, 2475 P.S.I. 3/4" "O" Ring Straight Pipe Thread Galvanized, Without Valve	includes	No. 0120 80 Cu. Ft. Galvanized Tank 3/4" "O" Ring Straight Pipe Thread
price	\$47.95		No. 1644 Constant Air Reserve Valve
		price	\$71.95

## 71.2 CU. FT. SINGLE TANK ASSEMBLIES

catalog no.	0180	catalog no.	0190
includes	No. 0110 71.2 Cu. Ft. Galvanized Tank	includes	No. 0110 71.2 Cu. Ft. Galvanized Tank
	No. 1652 High Pressure Valve		No. 1654 Constant Air Reserve Valve
price	\$53.45	price	\$71.95
<hr/>			
catalog no.	0181	catalog no.	0191
includes	Same as No. 0180 With Black Vinyl Coating on Tank	includes	Same as No. 0190 With Black Vinyl Coating on Tank
price	\$55.95	price	\$74.45



## 71.2 CU. FT. DOUBLE TANK ASSEMBLIES

catalog no.	0282	catalog no.	0292
includes	No. 0110 71.2 Cu. Ft. Galvanized Tank (2)	includes	No. 0110 71.2 Cu. Ft. Galvanized Tank (2)
	No. 1609 High Pressure Valve for Double Tank Assembly		No. 1653 Constant Air Reserve Valve for Double Tank Assembly
	No. 1446 Contoured Scubapak Double Tank Harness		No. 1446 Contoured Scubapak Double Tank Harness
price	\$142.45	price	\$147.45
<hr/>			
catalog no.	0283	catalog no.	0293
includes	Same as No. 0282 With Black Vinyl Coating on Tanks	includes	Same as No. 0292 With Black Vinyl Coating on Tanks
price	\$147.45	price	\$152.45

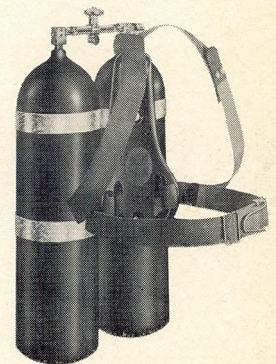

## 71.2 CU. FT. BARE TANKS

catalog no.	0110	catalog no.	0111
includes	71.2 Cu. Ft. Tank, 2250 P.S.I. Galvanized, Without Valve	includes	Same as No. 0110 With Black Vinyl on Tank
price	\$47.95	price	\$50.45



## CONTOUR SCUBAPAK

catalog no. 1445  
description **single tank harness**  
price **\$17.95**

Healthways Contour Scubapak incorporates all the outstanding features of the famous standard Scubapak—nylon webbing—easy-to-carry handles—continuous strap arrangement and quick release safety buckle. These features are incorporated without adding unnecessary bulk to achieve what a contour pack is designed to do. The Contour Scubapak is designed to eliminate large gaps in the back plate and the result is truly the most comfortable and form fitting contour pack ever developed. The Single Tank Harness features a new stainless steel single band design. This design provides a more secure tank attachment and incorporates an instant action quick release latch that allows removal of the Contour Scubapak in seconds.

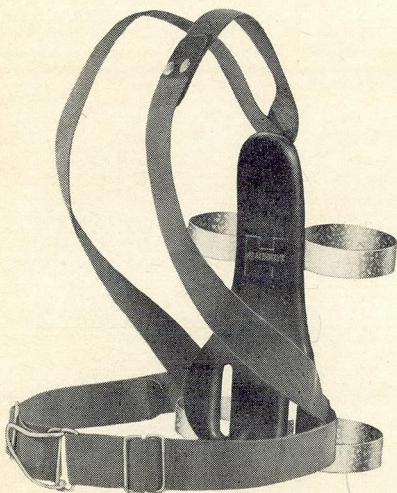

## CONTOUR SCUBAPAK

catalog no. 1446  
description **double tank harness**  
price **\$22.95**

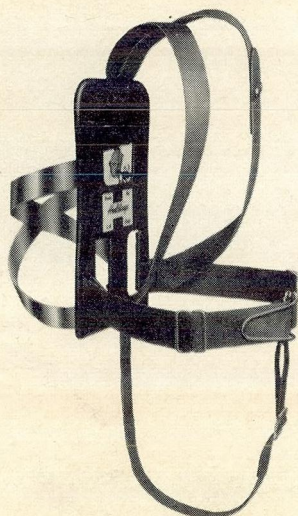

## SCUBAPAK

catalog no. 1443  
description **single tank harness**  
price **\$12.95**

The Scubapak is made of a single sheet of aluminum alloy that provides maximum safety, comfort and utility. A protective coating of high impact Vinyl makes the back plate impervious to salt water and the elements. The ends of the nylon webbing are dipped in rubber compound to prevent fraying. The Scubapak is equipped with Healthways quick release buckle, a crotch strap that may be used at the option of the diver plus a safety release shoulder strap. The Scubapak incorporates two easy-to-carry handles, designed as an integral part of the harness, which make carrying the tank as easy as carrying a suitcase. It features stainless steel "criss-cross" bands which incorporates an easy action thumb screw for quick assembly and removal of the Scubapak.



# PROFESSIONAL TANK VALVES

## HIGH PRESSURE VALVE

catalog no.	1652	1642
description	1/2" tapered pipe thread	3/4" straight pipe thread
price	\$9.95	\$11.95

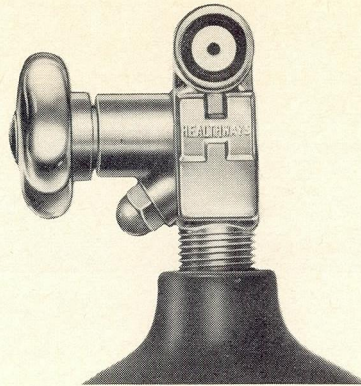

## CONSTANT AIR RESERVE VALVE

catalog no.	1654	1644
description	1/2" tapered pipe thread	3/4" straight pipe thread
includes	pull rod	pull rod
price	\$29.95	\$29.95

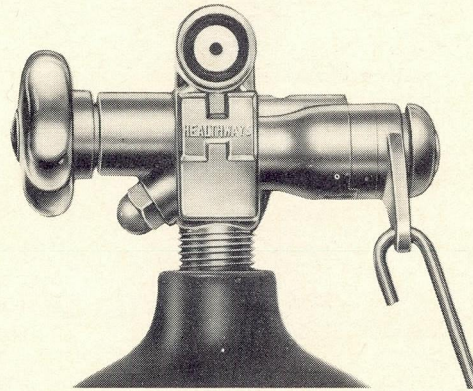

## HIGH PRESSURE VALVE FOR DOUBLE TANK ASSEMBLY

catalog no.	1609
price	\$31.95

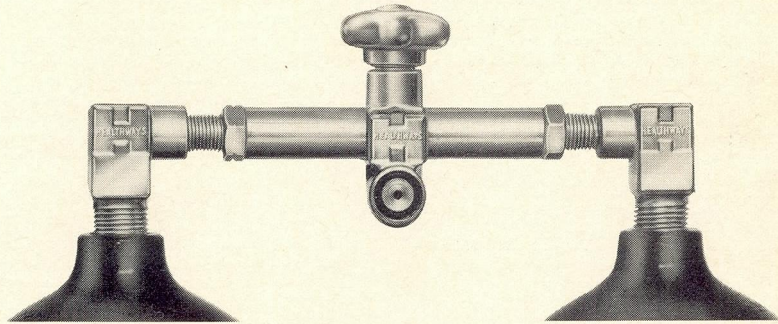

## CONSTANT AIR RESERVE VALVE FOR DOUBLE TANK ASSEMBLY

catalog no.	1653
includes	pull rod
price	\$46.95

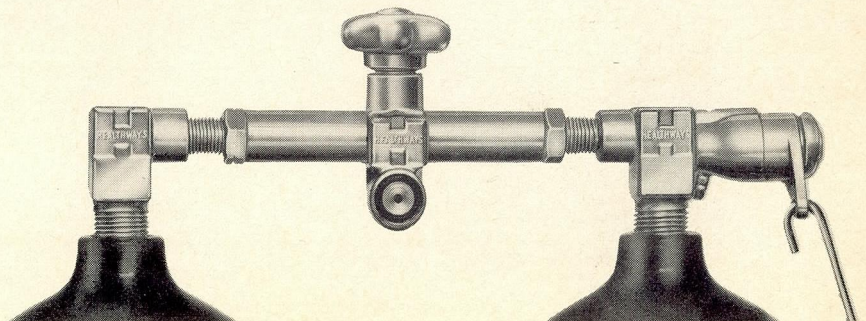



## SUBMERSIBLE STEM GAUGE

catalog no. **1604**  
price **\$16.95**

Healthways new Submersible Stem Gauge is designed with the foolproof simplicity and rugged durability required by ardent divers. This accurate, easy-to-read gauge is leak-proof, pressure-proof and unaffected by extremely rough use. It features a flexible HIGH PRESSURE HOSE with STAINLESS STEEL WIRE BRAID, BUNA liner, Neoprene outer covering and heavy chromed brass connections. Attaches to Healthways valves and regulators and enables the diver to know at all times how much air remains in the cylinder while diving.

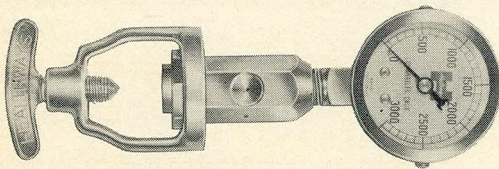
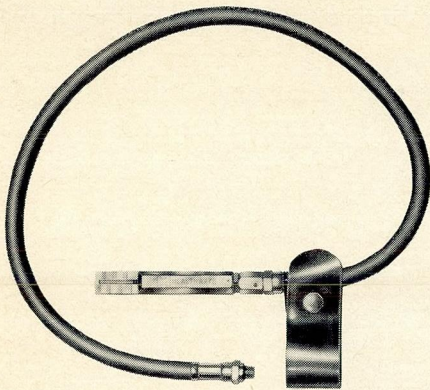

## PRESSURE GAUGE AND YOKE WITH BLEEDER VALVE

catalog no. **1614**  
price **\$9.95**

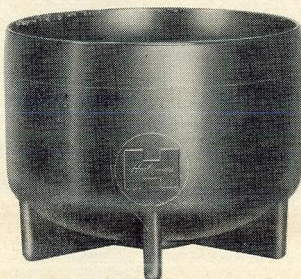

## TANK BOOT

catalog no. **1448**  
price **\$4.95**

A slip-on tank stand to protect boat decks and swimming pools. Made of durable Polyethylene. Boot can be easily removed from cylinder by injecting compressed air or water into small port on bottom.

Designed by G. Beauchat, the originator of the rubber powered speargun. Espadon spearguns are dependable all around spear fishing guns. Scientifically designed and balanced to float after release of the spear. They feature improved hand wrapped rubber power slings, tough high impact plastic handles, and a positive safety lever. The Espadons are corrosion and rust resistant.

## STANDARD ESPADON

catalog no. 1509  
price \$16.95

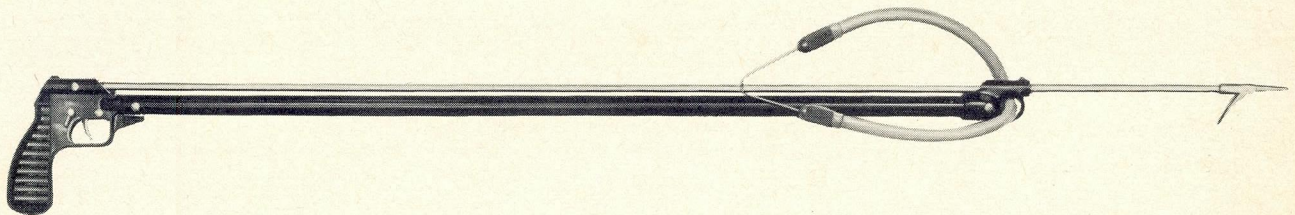

## JR. ESPADON

catalog no. 1508  
price \$14.50

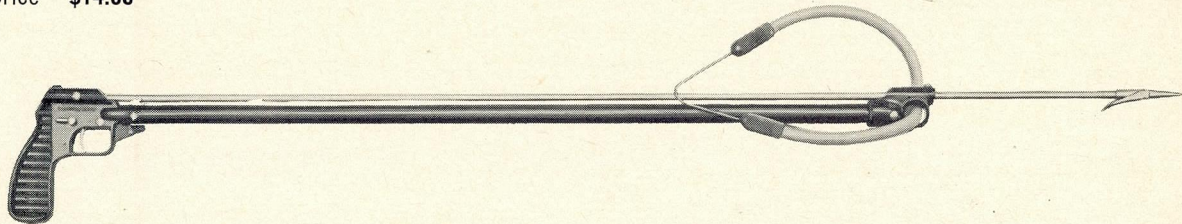

## BANTAM ESPADON

catalog no. 1507  
price \$11.95

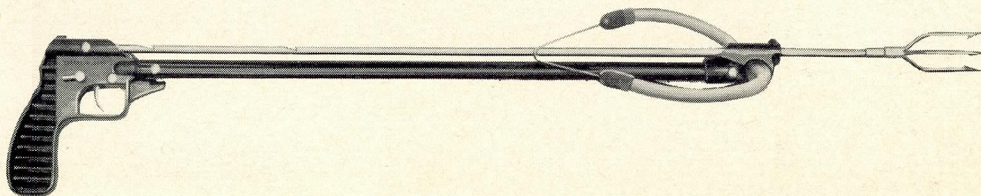

# SPEARFISHING GUNS



## PECHE-SPORT DELUXE (Center Grip)

catalog no. 1506  
price \$27.50

The original all metal, rust and corrosion resistant rubber powered spear-gun. Perfectly balanced to be weightless under water, they feature a comfortable pistol grip handle and a positive safety catch, and will float to the surface after the spear has been released.

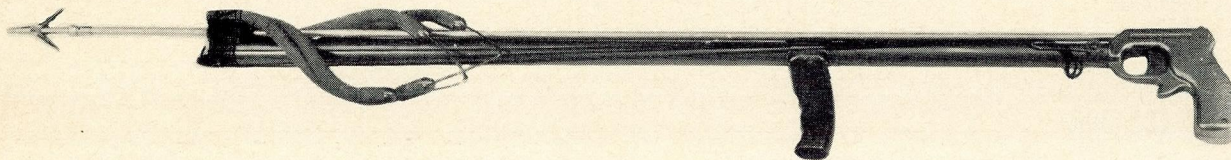

## GRESSI SAETTA

catalog no. 1531  
price \$19.95

Imported from Italy, Cressi guns are recognized as the finest in quality, accuracy and power. The Saetta is internally spring powered and constructed of non-corrosive materials throughout. The center pistol grip provides perfect balance for exceptional accuracy and maneuverability.

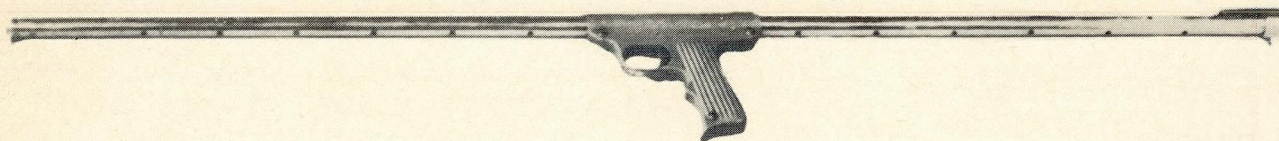

## DOUBLETTE

catalog no. 1529  
price \$19.95

A gun with two spears—one spear powered by rubber sling—the second by an internal spring. The Doublette is rust and corrosion resistant. The Doublette is perfectly balanced for ease in underwater handling. It has a pistol grip handle with positive safety catch for sling spear release and a center pistol grip with positive safety catch for spring powered spear release.

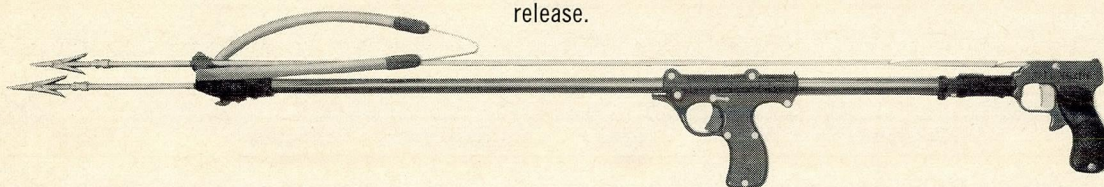

## "BIG JIM" SLING SPEAR GUN

catalog no. 1503  
price \$4.95

The "Big Jim" Sling Gun is modeled after the original Hawaiian design. The handle is molded of a durable rubber compound with a high impact polyvinyl core. The gum rubber sling may be adjusted by removing the knurled plastic knob. The 4 ft. spear shaft has a specially swedged point for exceptional long life.

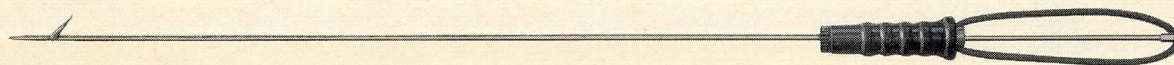





# SPEARHEADS AND ACCESSORIES

## GRESSI FIVE PRONG

catalog no. 1511-02  
price \$1.75

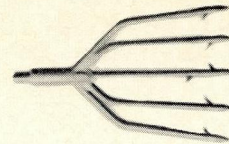

## GRESSI THREE BARB STAR

catalog no. 1500-06  
price \$4.50

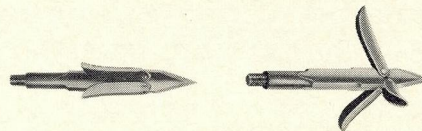

## GRESSI SPEARHEAD ADAPTER SLEEVE

catalog no. 1500-10  
description permits Cressi spearheads to be used on any Peche-Sport or French spear shafts  
price \$.75



## SINGLE BARB

catalog no. 1504-02  
price \$.98

## DOUBLE BARB

catalog no. 1505-02  
price \$1.98

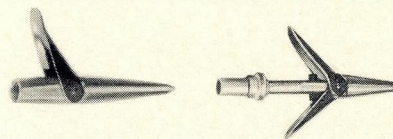

## TRI-POINT

catalog no. 1507-02  
price \$1.75

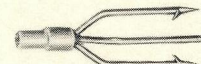

## SPEARHEAD ADAPTER

catalog no. 1513-10  
description permits use of all type spearheads  
price \$.75



## NOSE CLIPS (Not for SCUBA diving)

catalog no. 1915  
description made of pure Latex in standard sizes  
price \$.50

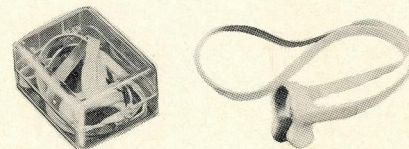

## EAR STOPPLES (Not for SCUBA diving)

catalog no. 1928  
description assorted sizes  
price \$.25

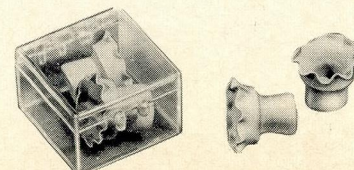

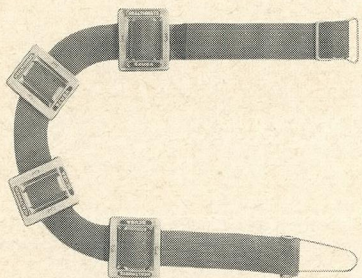

## PROFESSIONAL LEAD WEIGHT BELT

catalog no.	1942	1942-02
description	12 lbs.	2" web belt
price	\$14.95	\$2.95

Includes 4 No. 1944-01 3 lb. 'sandwich' lead weights, 1 No. 1942-02 2" Professional web belt, with Healthways new Jet-O-Sen quick release safety buckle that allows easy adjustment with a simple pull.

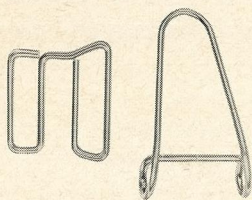

## JET-O-SEN 2" SAFETY BUCKLE ASSEMBLY

catalog no.	1942-04
price	\$1.75

A two-piece stainless steel assembly that fits 2" to 2 1/8" web belts and Scuba harnesses.

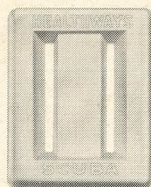

## SANDWICH LEAD WEIGHTS

catalog no.	1943-01	1944-01
weight	2 lbs.	3 lbs.
description	fits 2" web belt	fits 2" web belt
price	\$2.00	\$3.00

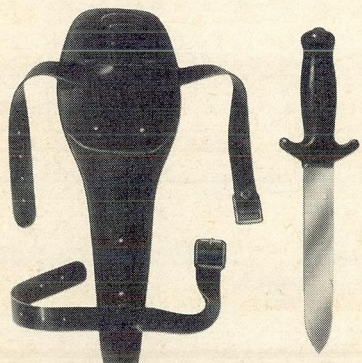

## ESPADON DELUXE KNIFE AND SHEATH

catalog no.	1985
price	\$9.95

An extra heavy duty, exceptionally strong, stainless steel knife with a Plastisol coated aluminum handle. The exclusive design of the sheath permits attaching to the calf of the leg.

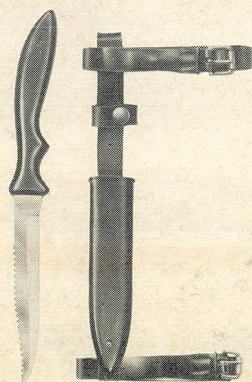

## "BIG JIM" DIVERS KNIFE AND SHEATH

catalog no.	1990
price	\$4.95

A compact utility knife with a 4 1/2" stainless steel blade and polished nylon handle. The specially designed sheath may be worn on the leg, arm, weight belt, or harness.

## SCUBALITE

catalog no. **1991**  
price **\$14.95**

The Scubalite with 80,000 candle power is the most powerful diving light ever developed for Scuba divers. The floating, pressure resistant, one piece body is made of high impact Marlex and features a completely water, pressure and corrosion proof switch and an easy to grip handle. The Scubalite may be used successfully to depths of over 200 ft. A simple quarter turn gives the lens a positive seal just as in the deep sea diver's helmet. (Uses 6 standard size "D" batteries, available everywhere.)

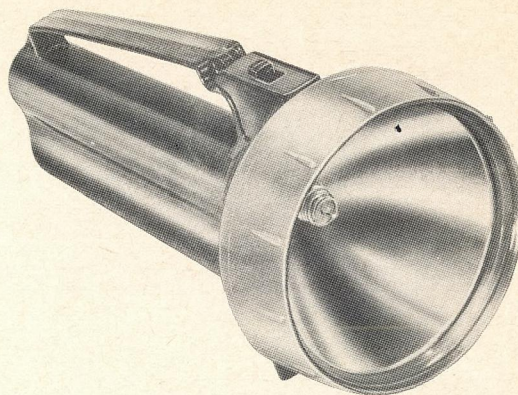

## GRUEN "SEA DIVE" DIVERS WATCH

catalog no. **1920**  
price **\$110.00**

A completely new divers watch designed with famous Gruen precision. Fully guaranteed by Gruen Watch Co. to withstand pressure at 600 feet of water. The "Sea Dive" features: automatic winding, 17 jewel Gruen Precision (R) movement, shock and dust proof crown, anti-magnetic, unbreakable mainspring, elapse time bezel. Comes complete with corrosion proof straps plus attractive stainless steel dress expansion band.

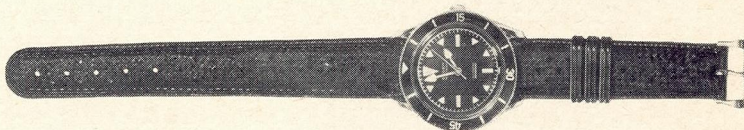

## 200 FT. DIVERS DEPTH GAUGE

catalog no. **1956**  
price **\$11.95**

Made with a corrosion proof, chrome plated brass housing, completely encased in rubber, and a form fitting wrist strap.

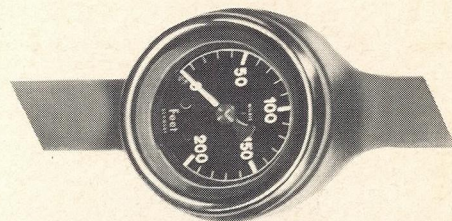

## 200 FT. DIVERS COMBINATION COMPASS AND DEPTH GAUGE

catalog no. **1958**  
price **\$13.95**

Made with a corrosion proof, chrome plated brass housing, completely encased in rubber, and form fitting wrist strap.



## 250 FT. AQUASTAR PROFESSIONAL COMPASS AND DEPTH GAUGE COMBINATION

catalog no. **1959**  
price **\$17.95**

A precise compass and depth gauge combination made of heavy chrome plated brass with a curved wrist fitting housing.

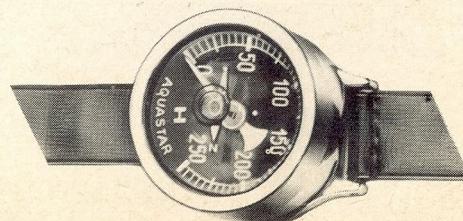



## AUTOMATIC DECOMPRESSION METER

catalog no. **1973**  
price **\$29.95**

With Healthways Automatic Decompression Meter there is no need to worry; you can always be sure. The precision instrument that functions automatically like an "electronic brain"—continuously memorizing repetitive and multiple depth dives. The Automatic Decompression Meter takes the guess work out of planning your dive. It records the two essential elements for each dive—TIME and DEPTH, automatically calculates these two factors and immediately indicates the necessary decompression time. The Automatic Decompression Meter reproduces the physiology of the body by duplicating the rate at which the nitrogen goes into and out of solution in the blood stream. Keeping an exact record of the dive completed and of the time you spent on the surface between dives, it uses the diving time as well as the surface time to automatically calculate and prescribe the decompression time necessary on the next dive. This process of memorizing continues for 6 hours after the last dive you make. The compact unit can be worn on the arm or attached to your harness.

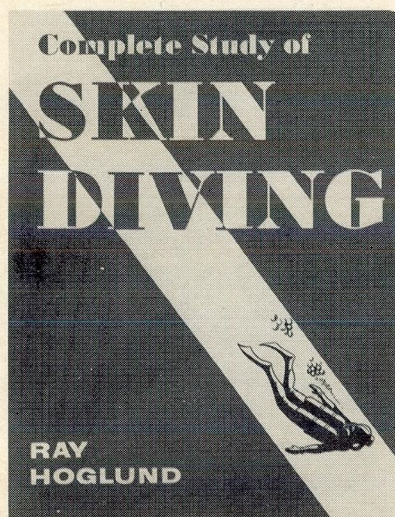

## COMPLETE STUDY OF SKIN DIVING

catalog no. **1911**  
author **ray hoglund**  
price **\$3.95**

Ray Hoglund, one of the nation's top Skin and SCUBA diving authorities, calls upon his vast background and personal experience to present this comprehensive and easy to read text. It guides the reader progressively through basic skin diving, SCUBA diving, physics of diving, physiology of diving, mechanics of diving to fundamental safety procedures. The knowledge gained from this book will be a valuable asset to anyone who desires a serious insight to the sport of diving.

## SCUBA-VEST LIFE JACKET

catalog no. 1988  
price \$9.95

Designed by Jim Christiansen. The Scuba-Vest is made of specially prepared material, the inside of which is completely saturated with a specially compounded leak proof coating. The Scuba-Vest is engineered to float an unconscious or resting diver in a "face-up" position. Experience has shown that although the Scuba-Vest is primarily a safety device it can be utilized for "that long swim back to the boat."

The Scuba-Vest is reversible. One side is professional black, the other side is officially approved international orange, the most vivid of colors for diving safety. In an emergency the diver wearing the black side out can easily reverse the vest to show the orange side out for easy identification. The Scuba-Vest is inflated by means of a "Squeeze Grip" detonator containing an oversized cadmium plated CO<sub>2</sub> cartridge. The re-usable detonator can be easily removed and a new CO<sub>2</sub> cartridge installed ready for instant re-use.



## DETONATOR

catalog no. 1988-02  
price \$3.00

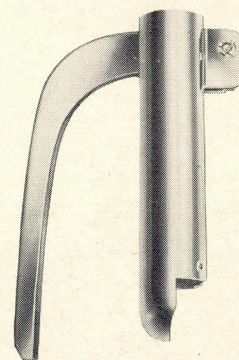

## CO<sub>2</sub> CARTRIDGE package of 6

catalog no. 1989  
price \$3.60

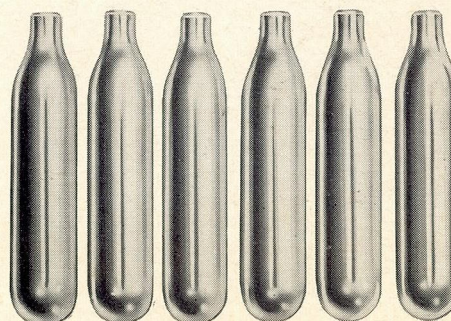



## "BIG JIM" DIVERS FLAG/BUOY

catalog no. 1981  
description **Weight not included**  
price **\$3.50**

The "Big Jim" Divers Flag/Buoy combines the conventional divers flag and a new inflatable marker buoy into one compact and functional unit. It is inflated by means of a single trouble-free plastic push-pull valve. It is designed with a two inch belt and buckle assembly that is permanently sealed to the base for attaching a conventional 2-lb. weight. This weight insures that the flag floats upright at all times.

U.S. Patent No. 195796, other patents pending.

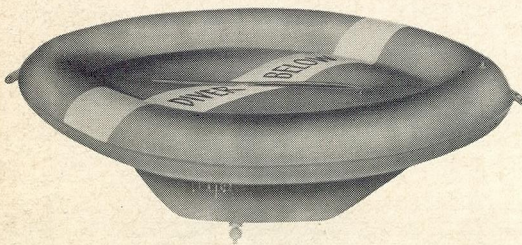

## UTILITY BAG/SAFETY FLOAT

catalog no. 1992  
price **\$6.95**

The most practical safety float ever designed. It combines an inflatable float, for use as a divers base and a zippered utility bag for storing gear. Made of heavy duty vinyl, 48" x 30".

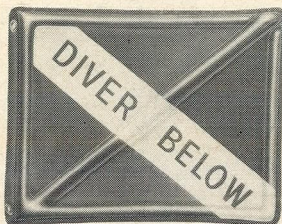

## INFLATABLE DIVERS FLAG

catalog no. 1969  
price **\$1.95**

The most practical divers safety flag ever devised. Made of heavy duty Virgin Vinyl with an inflatable rim that allows it to remain unfurled at all times.

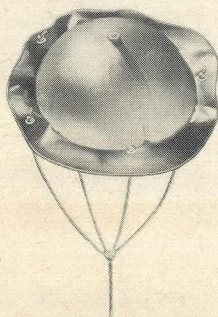

## MARKER BUOY

catalog no. 1987  
price **\$1.95**

A unique inflatable marker float. It can be used as a safety float in a pool or as a marker for the boating enthusiast or skin diver.



Healthways revolutionary products are presented in sales inviting packages that have won more national awards than any other sporting goods manufacturer. The packages are presented in bold, bright colors which permit instant recognition of contents. They are ideal for the construction of Point of Purchase Displays, window trimming, etc. Healthways also assists you with unparalleled dealer support by national advertising, radio, television, point of purchase and advertising displays.

