

SKIN AND SCUBA DIVING EQUIPMENT

1963

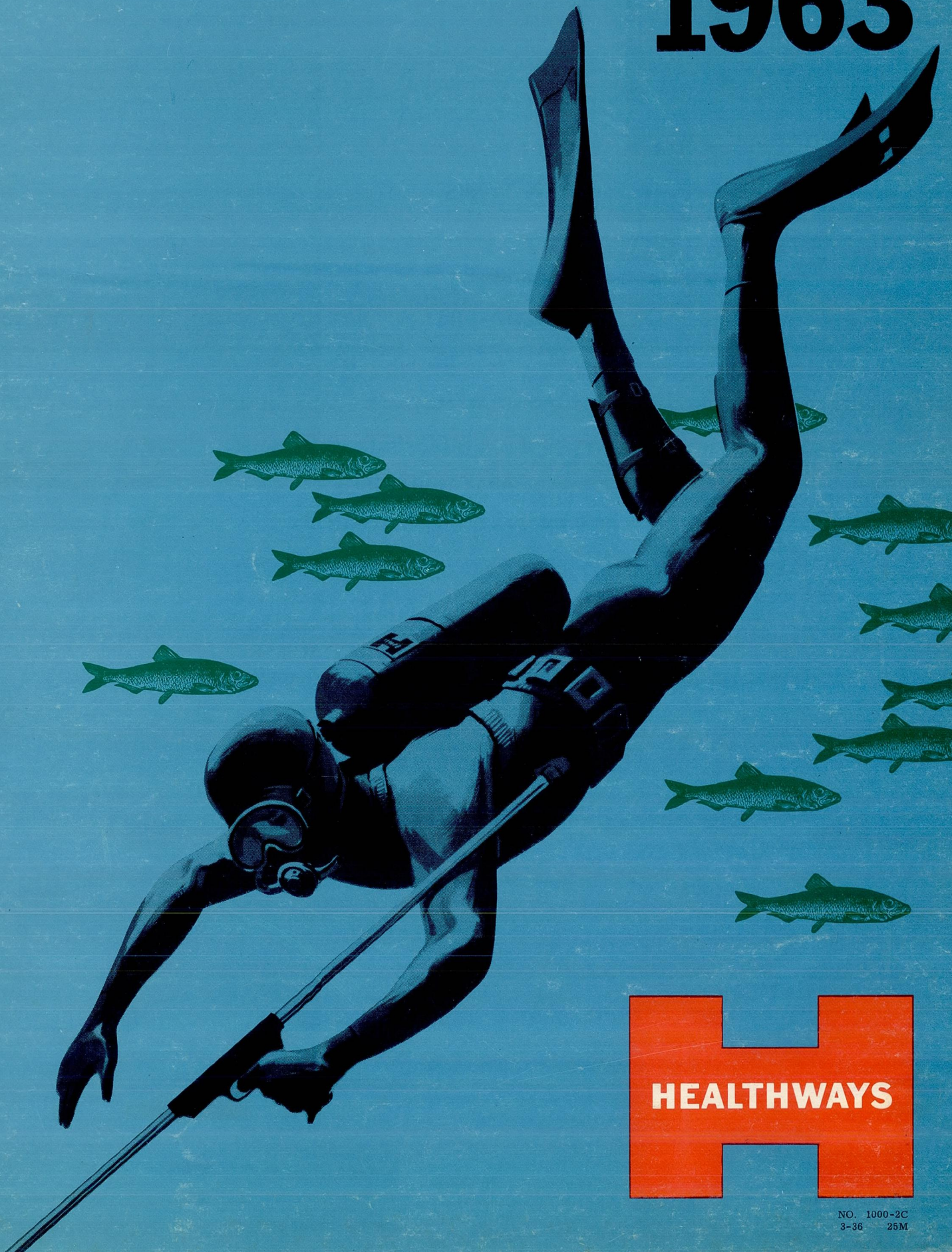

HEALTHWAYS

INDEX



DIVE MASKS	6-8
FINS	9-11
SNORKELS	12
REGULATORS	13-18
SURFACE AIR HOOK-UP	19
TANK ASSEMBLIES	20
SCUBA AIR COMPRESSORS	21
SCUBAPAK HARNESSSES	22-23
PROFESSIONAL TANK VALVES	24
SCUBA ACCESSORIES	25-26
SPEARFISHING GUNS	27-29
SPEARHEADS AND ACCESSORIES	30-33
DIVING SAFETY SECTION	34-37
SUBMARINES	38
INFLATABLE BOATS	39
UNDERWATER EXPOSURE SUITS	40-41
LLOYD BRIDGES' SEA HUNT POINT OF PURCHASE DISPLAY	42
SALES ORGANIZATION	43

VALVE

Professional tank valves specifically designed for divers — heavy forged brass — high pressure gauge outlet — low contour — easy action wheel — blowout proof “O” ring seal.

MASK

The finest rubber and Neoprene compounds. Tempered glass safety lens — stainless steel “Lens-Lock” band — feather edge seal.



SNORKEL

A combination of rigid and flexible pipe snorkels with comfortable contoured mouthpieces.

REGULATOR

Scubair Regulators. Professional engineering, simplicity, maximum air flow, provide minimum inhalation effort at any depth. Heavy chrome plated brass construction.

TANK

All Healthways tanks have durable galvanized finish. They are also available with the exclusive black Epoxy coating over galvanizing.

SUBMERSIBLE GAUGE

An accurate, leak proof, pressure proof gauge that is unaffected by extremely rough usage.

SUIT

Custom contoured fit with the seams permanently bonded by Healthways exclusive process.

WEIGHT BELT

Heavy duty two inch nylon webbing — stainless steel quick release buckle — non-slip contour weights.

AUTOMATIC DECOMPRESSION METER

A simple, infallible guide to diving safety. Automatically calculates required decompression time.

WATCH

An invaluable aid for planning and executing a dive safely. Contains elapsed diving time Bezel.

KNIFE

All purpose utility knife can be used to cut, hack, saw or even pry Abalones.

FIXE PALME

Insures maximum fin security.

ROUNDINE FINS

The most popular fin in the world. Maximum propulsion and comfort with minimum exertion.

THE
HEALTHWAYS
DIVER

HEALTHWAYS

RESEARCH AND DEVELOPMENT



HEALTHWAYS

VICTOR DeSANCTIS, after many years of scientific research, produced the absolute diving safety device, THE AUTOMATIC DE-COMPRESSION METER. Through this invention, Mr. DeSanctis will be honored as one of the greatest benefactors of diving safety. In collaboration with Healthways, he continues to research the science of decompression.

PUCCIARINI'S fame in the underwater world was first established as a member of the Italian Underwater Demolition Team, during the Second World War, when he helped create the one-man and two-man submarine. Mr. Pucciarini has developed two- and four-man submarines for the United States and Allied Navies. In collaboration with the Healthways Research and Development Division, he has developed the SEA SHARK and NAUTILUS.

PROFESSOR LUIGI FERRARI, an associate of Egidio Cressi and Director of the Research Department of Cressi-sub in Genoa, Italy, is recognized the world over as the greatest authority on underwater propulsion. His Rondine fin design and principles have set the pace in fin development. The Super Rondine Fins are the latest creation by Professor Ferrari, in collaboration with the Healthways Research and Development Division.



GUSTAV DALLA VALLE, Director of Healthways Diving Research and Development Division, is a world-famous diver and underwater pioneer. Because of a compelling feeling of responsibility toward every fellow diver, he personally tests, under the most trying conditions, every item manufactured under his control. A wealth of underwater experiences in all the waters of the world and his ingenuity have been the foundation for his success in bringing to divers everywhere the safest, most advanced and most practical equipment in existence.

His life has always been devoted to the promotion of the diving sport. He is greatly responsible for introducing diving on a popular basis to the United States by presenting to the American market the first full-foot fin, the Cressi

Rondine, which today is the most popular fin in the world.

Dalla Valle's international reputation and his renown as one of the outstanding pioneers and developers in the underwater field have earned the respect and the cooperation of the world's most outstanding underwater scientists.

Healthways Research and Development Division, under Dalla Valle's guidance and with the cooperation of the world's leading underwater scientists, assures that every Healthways product is the most advanced and the finest available.



RICHARD E. ANDERSON graduated from the Sparling School of Deep Sea Diving in 1953. Because of his mechanical background, he immediately became interested in the design and development of underwater equipment. He was one of the first diving mechanical engineers in the United States who was engaged in the study and development of SCUBA apparatus.

In 1954 Richard Anderson joined Healthways Research and Development Division and has since added his experience and ability to produce the world's finest line of regulators. His development of the Scubair regulators has been an important contribution to the safety and advancement of the underwater sport.



JIM CHRISTIANSEN, the most famous and respected American diver, and one of the foremost advocates of diving safety education, is the developer of Healthways SCUBA-VEST. All experts agree that the SCUBA-VEST is the greatest contribution to diving safety made in many years. He was USA National Spearfishing Champion in 1956 and 1957, and Athlete of the Year in 1957. He has been Coach of the American National Spearfishing Team since 1957, and is now a full-fledged member of Healthways Research and Development Division.

DAVID R. DENIS, B.S.M.E., is in charge of all engineering activities and of manufacturing and production control at Healthways. A mechanical engineer and graduate of the University of Florida, he was formerly a member of the Research Division of Standard Oil of New Jersey. His scientific contribution in the development of new products has made Healthways products the best-engineered in the world.

ELLIS R. CROSS, Master Diver, is a former Naval Officer and former owner of the world-famous Sparling School of Deep Sea Diving. Cross was on the staff of the Commander of the Ship Salvage Unit at Bikini during the atom bomb tests. He was a delegate to the Conference for National Cooperation in Aquatics at Yale University, on Underwater Safety.

Cross is the author of Healthways "UNDERWATER SAFETY," and several technical diving books specializing in the psychology of diving, diving diseases, diving physics and diving equipment. His contributions of equipment and diving safety through the Healthways Research and Development organization are of great consequence.

EGIDIO CRESSI, Director General of Cressi-sub in Genoa, Italy, and a pioneer of the diving sport, is one of the first manufacturers of diving equipment. He is world-famous for his continued contribution to the underwater sport by developing new and safer products. Cressi products are known as the most advanced professional diving equipment available.



Vice President and General Sales Manager Randolph K. Stone, inspects production model Scubair Regulator with Gustav Dalla Valle, director of Research and Development; Richard E. Anderson, Chief SCUBA Engineer; and Professor Luigi Ferrari, SCUBA Designer and Scientific Consultant.

RESEARCH AND DEVELOPMENT

HEALTHWAYS

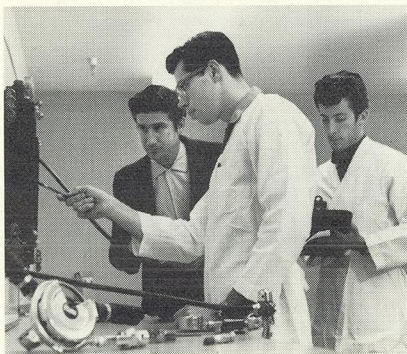

Chief SCUBA Engineer Richard E. Anderson checks results of regulator flow test with his laboratory assistants.

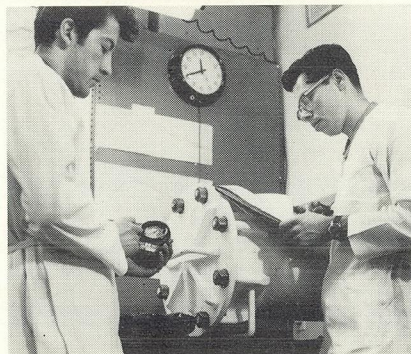

Lab technicians Roberts and Castillo run exhaustive tests on Automatic Decompression Meters in air chamber that can simulate depths to 1000 feet.

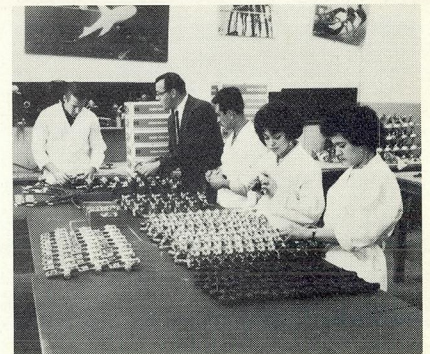

Highly trained assembly personnel work under the careful inspection of Chief Engineer David R. Denis.

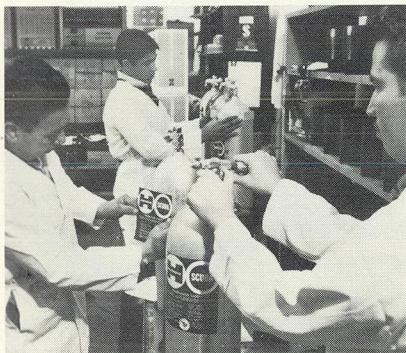

Scubapak Harnesses and identifying labels are put on Healthways SCUBA Tanks after thorough testing and filling.



Modern inspection and packaging techniques speed production of world famous Cressi Rondine Fins.

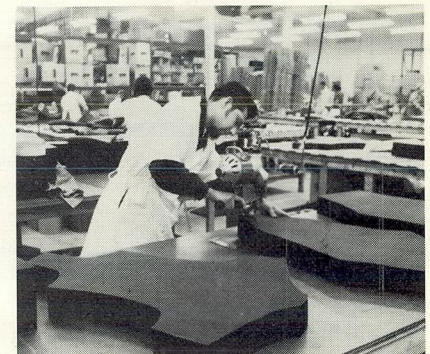

Healthways modern suit production ensures consistent high quality comfort and fit.

DIVE MASKS

HEALTHWAYS

Healthways dive masks are the result of the combined experience and knowledge of the world's foremost American and European divers. They are designed and manufactured with consideration of the most important factors — quality, workmanship and utility.

STABILIZATOR MASK



No. 1260
Professional Black
\$5.95

The world's most popular mask incorporates finger wells for pressure compensation of the ears. The Stabilizator Mask features stainless steel "Lens-Lock" band—tempered glass lens—split head strap for secure fit—comfortable feather edge seal.

STABILIZATOR "CLEAR-EASE"

No. 1261
Professional Black
\$6.95

The Stabilizator "Clear-Ease" Mask incorporates all the outstanding professional features of the Stabilizator, plus Healthways simple and efficient non-return valve which allows the diver to clear water from the mask in the normal swimming position. The Stabilizator "Clear-Ease" features stainless steel "Lens-Lock" band—tempered glass lens—split head strap for secure fit—comfortable feather edge seal.



PINOCCHIO PROFESSIONAL



No. 1243
Professional Black Neoprene
\$8.95

The exclusive nose design makes the Pinocchio the ultimate in pressure compensating masks. Accepted and used by the world's leading professional and sport divers. Minimum air displacement will allow up to 25% greater skin diving depth. The double feather edge provides a comfortable and absolute, leak-proof seal. The Pinocchio Professional features molded Neoprene for resistance to oil, wear, salt water and the elements — tempered glass lens — chrome plated "Lens-Lock" band — split headstrap for secure fit.

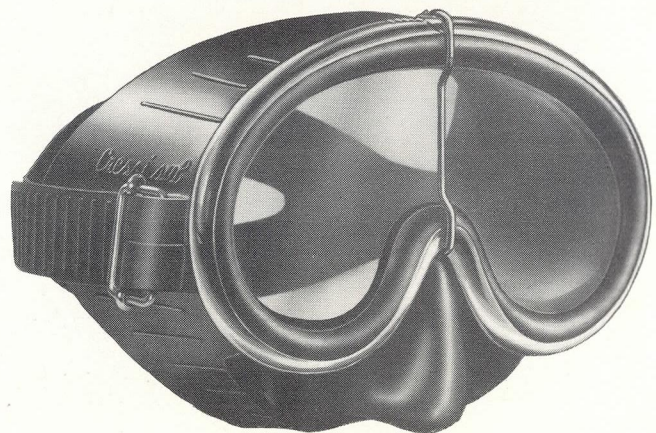

PANORAMIQUE "CLEAR-EASE"

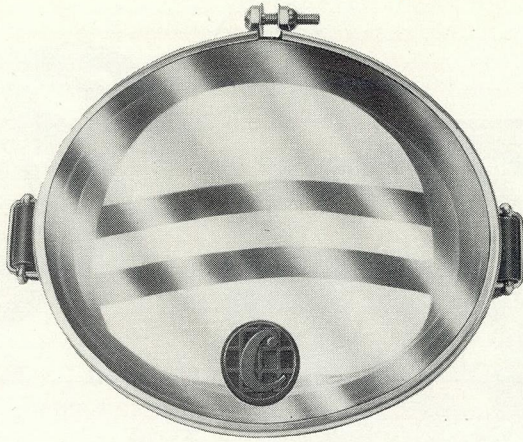
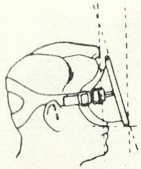

No. 1224
French Blue
\$5.95

The Panoramique has obtained world-wide acceptance due to its outstanding features. The exclusive "wide-angle" design brings the lens closer to the eyes at a slant that offers undistorted vision over a wider range. The Panoramique "Clear-Ease" incorporates the well-proven "Clear-Ease" non-return valve that allows water to be cleared from the mask while in a normal swimming position. The Panoramique "Clear-Ease" features tempered glass lens—stainless steel "Lens-Lock" band—split head strap for secure fit—comfortable feather edge seal.

DIVE MASKS

HEALTHWAYS



No. 1220
French Blue
\$3.95

No. 1250
Yellow
\$3.95

No. 1270
Professional Black
\$3.95

The Espadon Dive Mask is a high quality, light weight professional mask designed primarily for smaller faces. The Espadon features tempered glass lens—stainless steel "Lens-Lock" band—split headstrap for secure fit—comfortable feather edge seal.

ESPADON



No. 1222
French Blue
\$4.95

No. 1252
Yellow
\$4.95

No. 1272
Professional Black
\$4.95

The exclusive design of the Panoramique "Wide-Angle," the world's most popular mask, brings the lens closer to the eyes at a slant that offers undistorted vision over a wider range. The Panoramique Mask features tempered glass lens—stainless steel "Lens-Lock" band—split headstrap for secure fit—comfortable feather edge seal.

PANORAMIQUE



No. 1228
Blue
\$2.95

The Cressi Star is a high quality, light weight mask that features stainless steel "Lens-Lock" band—safety lens—split head strap for secure fit—comfortable feather edge seal. The best value at this price.

CRESSI STAR

DIVE MASKS



OSTRICA MASKS



**No. 1239
Ostrica Jr.
\$3.95**



**No. 1240
Ostrica Bantam
\$3.50**

The only professionally designed, high quality mask for smaller faces. The Ostrica masks feature tempered glass lens—stainless steel “Lens-Lock” band—comfortable feather edge seal—split headstrap for secure fit.

AQUA CHAMP



**No. 1201
Aqua Champ Special
Blue
\$1.00**

This well-fitting junior mask is molded of high quality rubber with Healthways exclusive “bend edge” design and clear Styrene lens.



**No. 1202
Aqua Champ Sr.
Blue
\$1.50**

The popular round mask features quality rubber compound, “bend edge” design and clear shatterproof lens.

PROFESSIONAL

**No. 1211
Amber Gum Rubber
\$3.95**

The ever popular pioneer of heavy-duty gum rubber dive masks. The Professional features double strength glass lens — stainless steel “Lens Lock” band — extra wide headstrap for secure fit — exceptional feather edge seal.



GOGGLES

**No. 1107
Aqua Pro Goggles
Yellow
\$3.25**

These world famous Goggles are professionally designed for maximum safety and feature quality rubber compound — tempered glass lens — feather edge seal.



**No. 1261-06
Clear-Ease Valve
\$.25**



**No. 1243-07
Cressi Clear-Ease Valve
\$2.00**

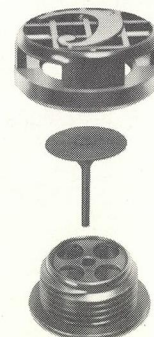

WHY RONDINE FINN OUTSELL ALL OTHERS FIVE TO ONE

Created by Cressi, the most renowned manufacturer of underwater sports equipment. The Rondine Fins have achieved worldwide acceptance as the finest in design, construction, fit and performance. The scientifically designed Cressi Rondine is the most copied (but never duplicated) fin in the entire history of underwater sports. Only the Cressi Rondine offers these outstanding features:

- Blade angle which provides maximum thrust with minimum effort.
- The original full foot, open toe design which assures a comfortable fit.
- Shoe sizes increase in width as well as length in the proper proportions.
- Light weight — less bulk.
- Specially integrated rubber compounds assure comfortable fit and efficient blade action.

U. S. Patent No. 2737668

RONDINE FINN

HEALTHWAYS

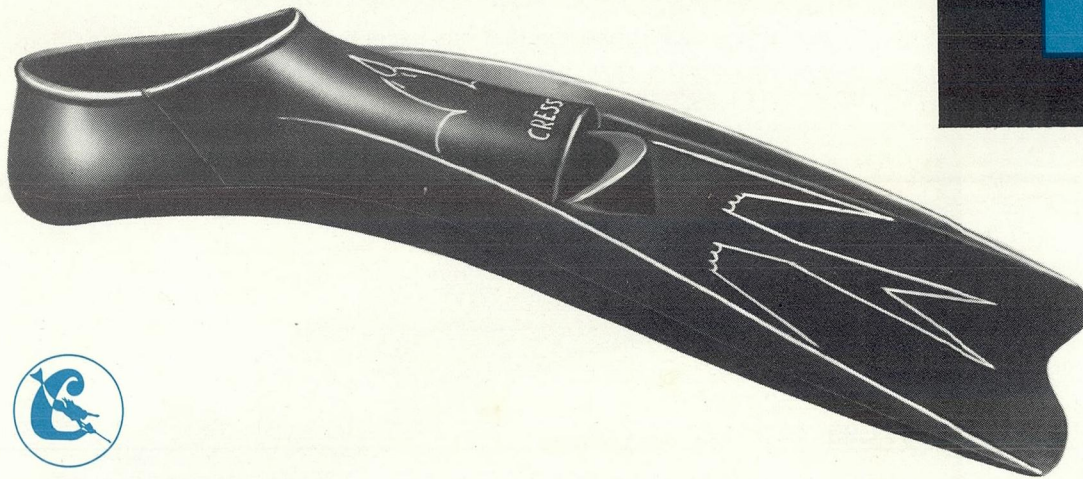

RONDINE JUNIOR

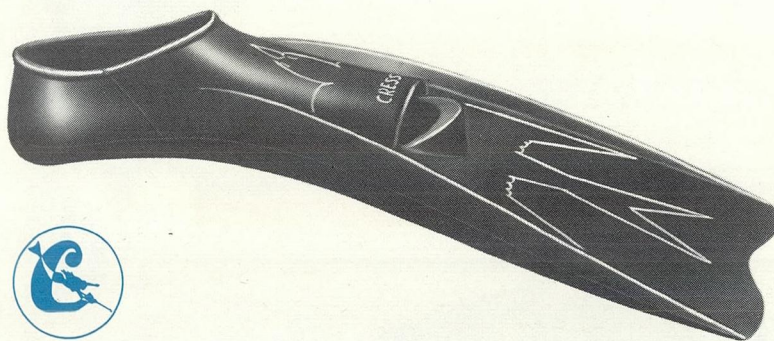

Blue

No. 1373	Size 2-3	\$5.95
No. 1374	Size 3-4	\$5.95
No. 1375	Size 4-5	\$5.95

The Rondine Junior incorporates all the features of the professional Rondine fins, in sizes to fit young people. These light weight fins are exceptionally comfortable.

RONDINE ADJUSTABLE

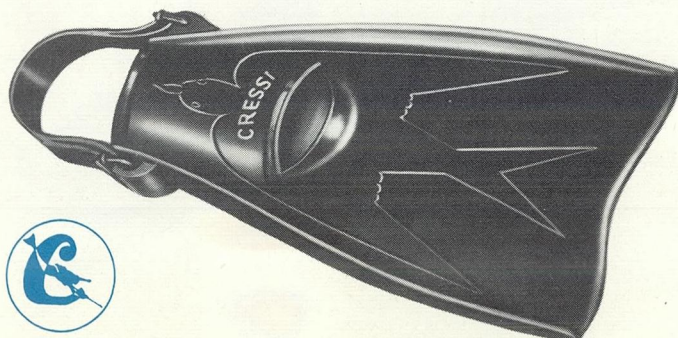

Blue

No. 1381	Size 1-5 (small)	\$5.95
No. 1382	Size 5-10 (medium)	\$5.95
No. 1383	Size 10-14 (large)	\$5.95

The Rondine Adjustable was created for the discriminating diver who prefers the adjustable open heel design. The comfortable contoured strap and safety-lock buckle plus the Rondine blade design make this the finest adjustable fin in the world.

RONDINE FINS



GENOA

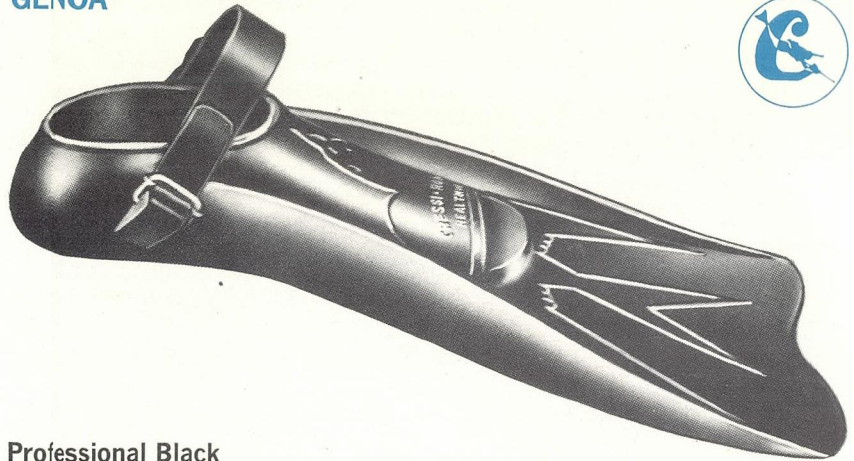

Professional Black

No. 1330	Size 5-7 (without strap)	\$7.95 ✕
No. 1331	Size 7-9 (without strap)	\$7.95 ✕
No. 1334	Size 9-11 (w/adjustable strap)	\$9.95 ✕
No. 1335	Sizes 11-13 (w/adjustable strap)	\$9.95
No. 1336	Size 13-16 (w/adjustable strap)	\$10.95

The original black rubber fin that has become a worldwide leader in popularity. The Genoa is designed to provide maximum propulsion from its fin tip and side rigidity and at the same time offer form-fitting comfort.

MEDITERRANEAN

Blue

No. 1350	Size 5-7	\$10.95
No. 1351	Size 7-9	\$10.95
No. 1352	Size 9-11	\$10.95
No. 1353	Size 11-13	\$11.95

Made of floating rubber compound, the Rondine Mediterranean combines the comfort, fin tip rigidity and rugged light weight construction desired by all divers.

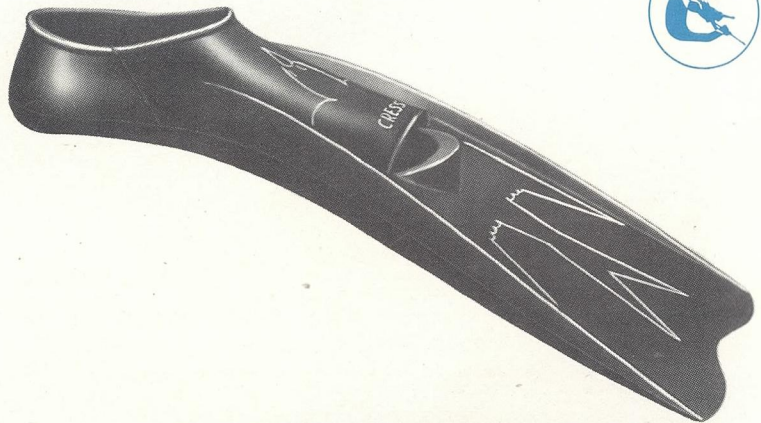

GARIBALDI

Yellow

No. 1360	Size 5-7	\$11.95
No. 1361	Size 7-9	\$11.95
No. 1362	Size 9-11	\$11.95
No. 1363	Size 11-13	\$11.95

The Rondine Garibaldi is made of a special floating, yellow rubber compound which allows easy identification. It has exceptionally light weight construction, comfort and fin tip rigidity.

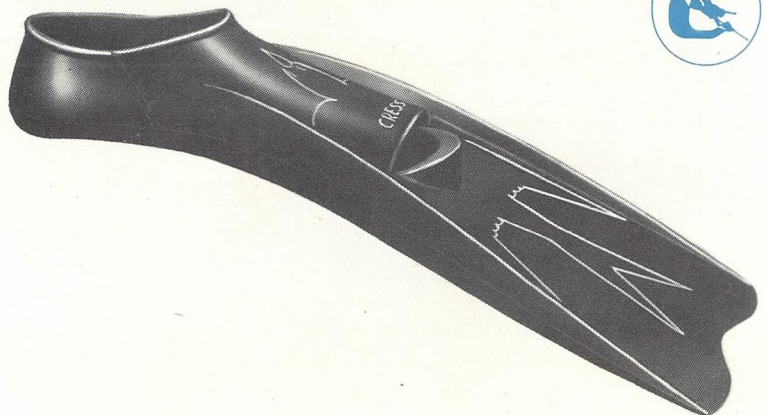

WATER DOGS

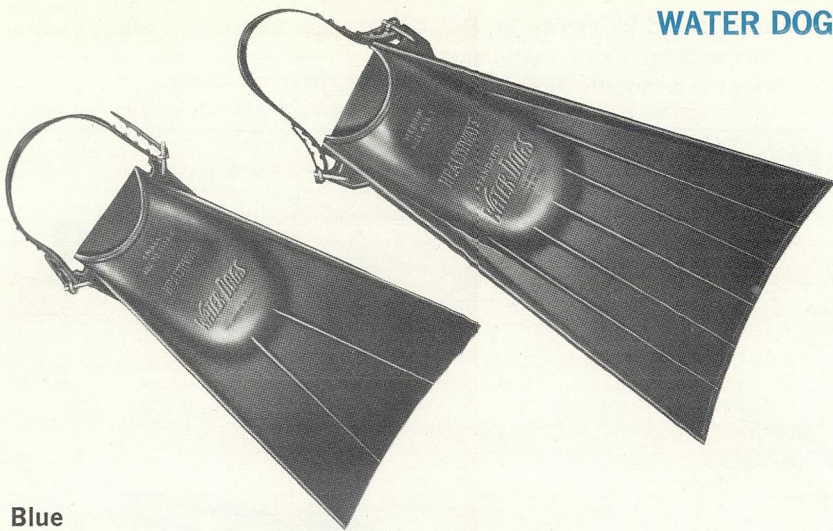

Blue

No. 1302	Adjustable to Size 6	\$2.95
No. 1303	Size 4-8	\$3.95
No. 1304	Size 8-13	\$3.95

Healthways Water Dogs combine quality and professional design with exceptional durability and lightness. These all-around fins are molded of a special rubber compound and feature an adjustable strap and non-slip safety buckle.

FINS & ACCESSORIES

HEALTHWAYS

FIXE PALME

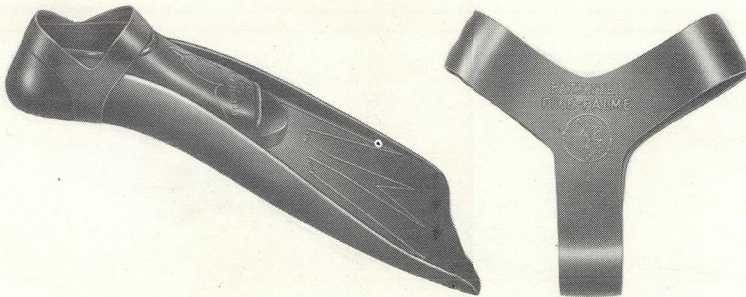

Professional Black

No. 1370	Size 7-11 (medium)	\$1.75
No. 1371	Size 9-16 (large)	\$1.75

The universal Fixe Palme holds any closed heel fin to your foot under the most turbulent conditions. The Fixe Palme provides absolute fin security by holding the fin in three places—instep, arch and heel.

RONDINE MINIATURE

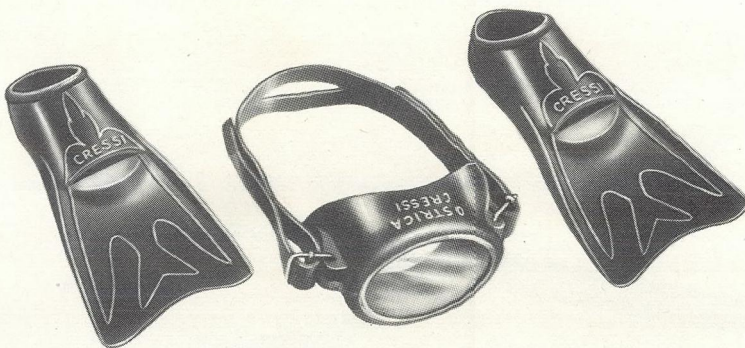

Blue

No. 1237

Cressi Rondine Miniature Fins and Mask Set
\$.95

These detailed miniatures of the famous Cressi Rondine Fins and Mask are much sought after as momentos and are ideal for premiums or promotions.

No. 1281
Skin Diver Doll
\$1.50

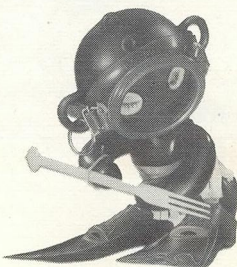

No. 1282
Scuba Diver Doll
\$1.95



CRESSI DIVER DOLLS

These clever 5" dolls are popular gifts. They are made of unbreakable Polyethelene and come fully equipped with scale miniatures of the famous Cressi masks, fins, and spearguns.

SNORKELS



The snorkel, used primarily by skin divers, is also an important safety device to the Scuba Diver who surfaces with an empty tank. It enables him to breathe normally during that "long swim back to the boat."

CRESSI DELFINO

No. 1430
Blue
\$1.95

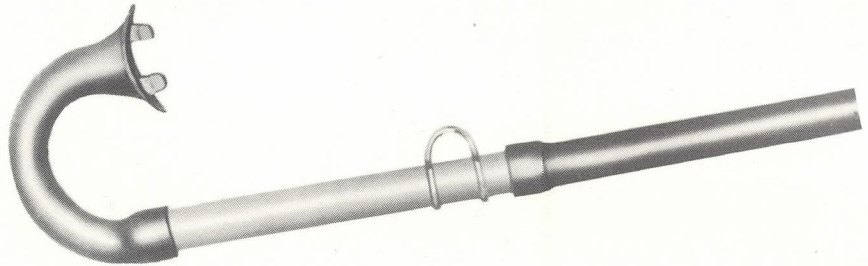

The snorkel preferred by professionals. The Cressi Delfino is made of a one-piece rubber elbow and mouthpiece with a rigid plastic center pipe and a flexible upper section of gum rubber.

CRESSI HAITI PROFESSIONAL

No. 1432
Professional Black
\$1.95

The choice of professional divers in both style and construction. The Haiti Professional is made of the finest quality black rubber combined with a soft, flexible, accordion mouth piece.

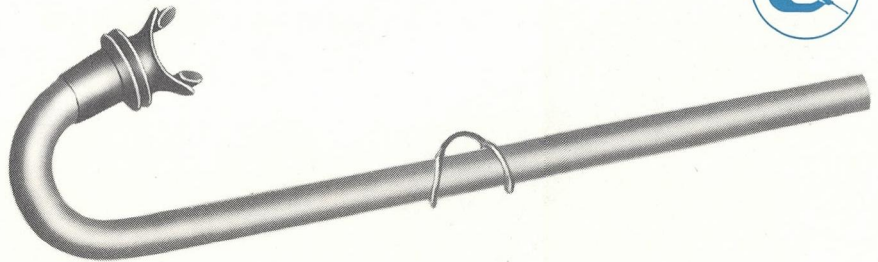

SEA SCOUT

No. 1403
Assorted Colors
\$1.00

A straight professional type snorkel of durable Polyethelene with a soft vinyl mouthpiece.

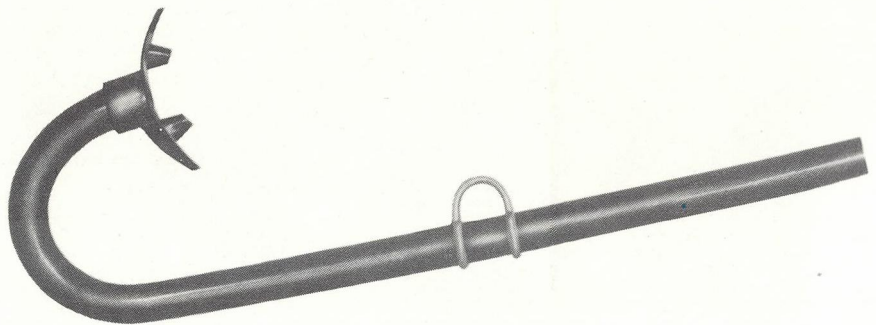

SEA DIVE STANDARD

No. 1405
Assorted Colors
\$1.00

A popular professional type snorkel with a soft Vinyl mouthpiece and "check ball" cage.

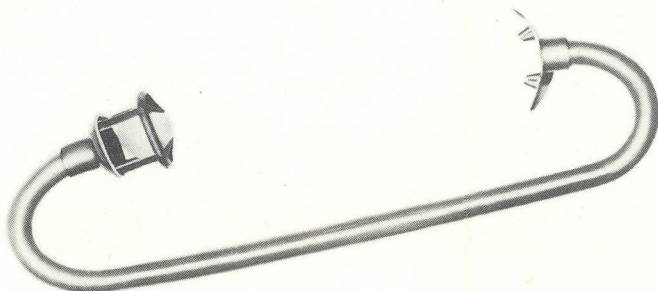

Healthways exclusive diver proven double exhaust valve has as great a significance as the non-return mouthpiece in a double hose regulator. This unique feature assures the diver of an absolute dry air supply under all conditions. ONLY HEALTHWAYS SINGLE HOSE REGULATORS HAVE THIS ADVANCED SAFETY FEATURE. All Healthways single hose regulators feature a contoured air exhaust to prevent air bubbles from obstructing vision (it is made of chrome plated brass and is permanently attached for maximum safety)—snag proof clearing button to activate the demand valve—nylon reinforced Neoprene diaphragm with stainless steel diaphragm discs — “Quik-Klip” to facilitate inspection and maintenance—leak proof “O” ring seals for maximum safety — newly improved easy turning hose swivel to prevent twisting and kinking of hose. All Healthways second stages are made of heavy gauge chrome plated brass and are impervious to salt water and the elements.

SECOND STAGE

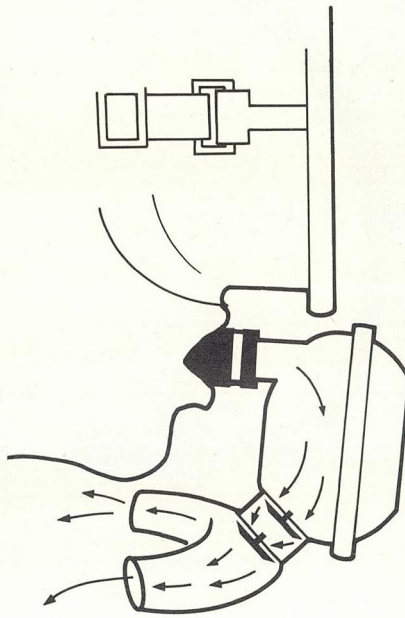

REGULATORS

HEALTHWAYS

SCUBA STAR FIRST STAGE

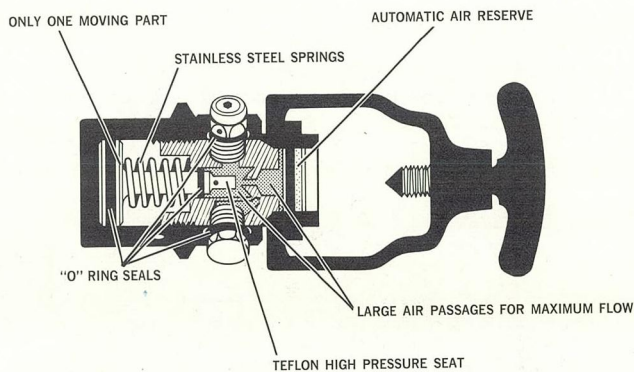

SCUBAIR FIRST STAGE

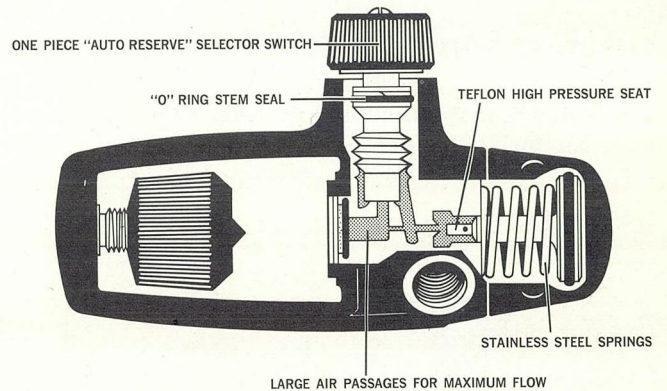

SCUBAIR "J" FIRST STAGE

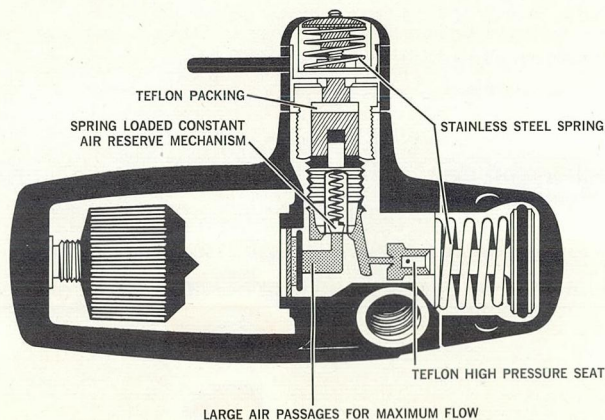

SCUBAIR "300" FIRST STAGE

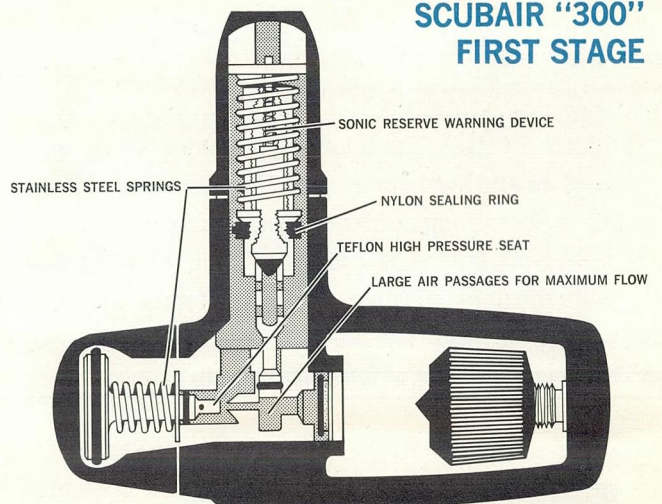

SCUBA STAR

HEALTHWAYS

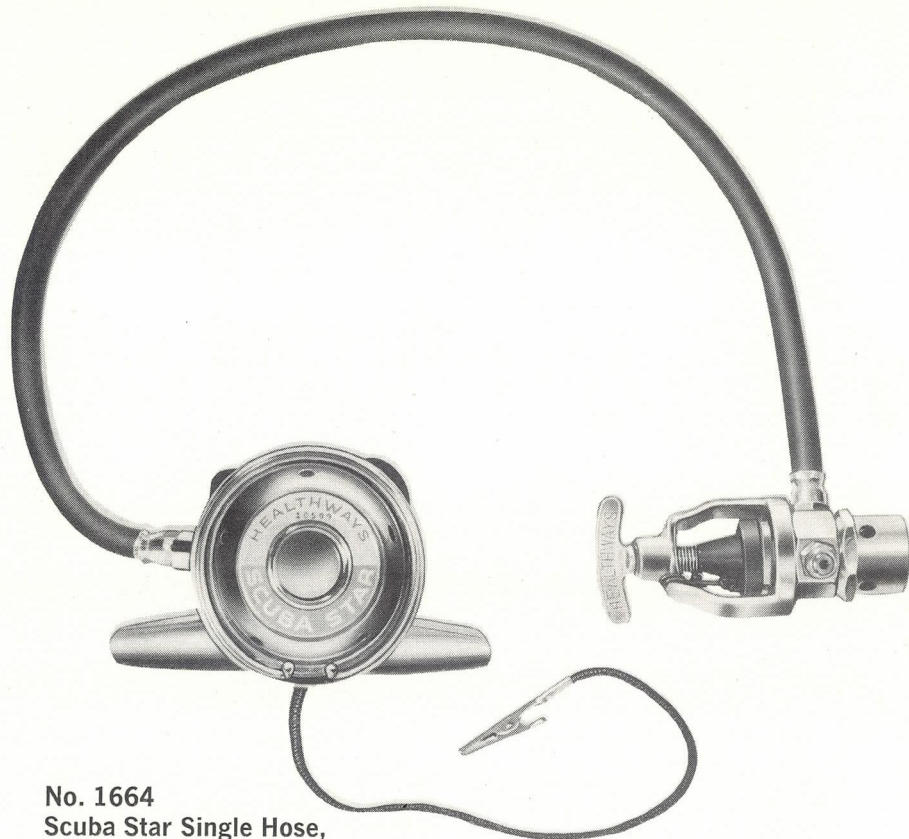

No. 1664
Scuba Star Single Hose,
Two Stage Regulator
\$34.95

Pat. Pending

THE WELL-PROVEN PIONEER OF "O" RING PISTON REGULATORS

The Scuba Star is not limited to "shallow water" or "sport diving," it is professionally designed and engineered to be used comfortably to depths of 200 feet.

FIRST STAGE: The Scuba Star first stage has only one moving part which makes it outstanding in function, simplicity and maintenance. It proved that the troublesome "high pressure block leak" could be eliminated. A depth compensated automatic air reserve "K Restrictor" is assembled into the high pressure block. It can be easily replaced with the "J Restrictor" if the diver prefers to use a constant air reserve valve. A safety relief valve is incorporated into the first stage which eliminates the possibility of over pressurizing the regulator. (This safety relief valve is sometimes referred to as the "third stage" in a two-stage regulator.) The Scuba Star first stage features a high pressure plug which can be removed and the Submersible Gauge installed to enable the diver to know at all times how much air remains in the cylinder while diving. The first stage is machined from solid brass with a forged yoke and screw, and features a heavy chrome finish.

SECOND STAGE: The Scuba Star second stage features Healthways unique double exhaust valves, which assures the diver of an absolute dry air supply under all conditions. The one piece tilt valve demand mechanism provides the diver with easy breathing and offers foolproof simplicity. The Scuba Star second stage features contoured exhaust to prevent bubbles from obstructing vision — "Quik-Klip" to facilitate inspection and maintenance — snag proof clearing button to activate the demand valve — nylon reinforced Neoprene diaphragm with stainless steel diaphragm disc — leak proof "O" ring seals for maximum safety — easy turning hose swivel — high test nylon and Neoprene hose. The Scuba Star second stage is constructed of heavy gauge chrome plated brass, all stainless steel springs, and is impervious to the elements.



Pat. Pending

No. 1665
Scubair Single Hose,
Two-Stage Regulator
\$49.95

SCUBAIR

HEALTHWAYS

THE MOST WIDELY ACCLAIMED REGULATOR IN THE HISTORY OF SELF-CONTAINED DIVING

FIRST STAGE: The Scubair first stage has the most efficient and functional design of any single hose regulator. It incorporates the foolproof "O" ring piston pressure reduction mechanism — only one moving part. A manually operated air reserve selector switch enables the diver to adjust his regulator to the automatic depth compensated "Auto Reserve" position or to the "J Valve" position, if the diver prefers to use the constant air reserve valve on his cylinder. (This pre-dive adjustment is to be made before turning on the cylinder valve.) Healthways exclusive internal yoke screw eliminates the conventional wing nut and provides an easily operated, snag proof means of attaching the regulator. Finger tip control is all that is necessary for a complete seal with the modern "O" ring valves. The Scubair first stage contains a high pressure plug which can be removed and the Submersible Gauge attached to enable the diver to know at all times how much air remains in the cylinder while diving. A removable low pressure plug provides for the attachment of an additional second stage for training purposes. The Scubair first stage body is made of chrome plated forged brass, all stainless steel springs and is impervious to the elements.

SECOND STAGE: A "downstream" demand mechanism is engineered into the Scubair second stage to deliver more air than any diving regulator available. This downstream demand valve automatically serves as a safety relief valve in case of an over pressure in the air supply hose. The balanced Venturi system allows the diver to breathe comfortably at any depth with no increase in inhalation effort. The Scubair second stage features double exhaust valves—contoured air exhaust to prevent bubbles from obstructing vision—recessed snag proof clearing button—nylon reinforced Neoprene diaphragm—"Quik-Klip" to facilitate inspection and maintenance—leak proof "O" ring seals for maximum safety—easy turning hose swivel—The Scubair second stage is constructed of heavy gauge chrome plated brass, all stainless steel springs and is impervious to the elements.

Developed by Richard E. Anderson

SCUBAIR "J"

HEALTHWAYS

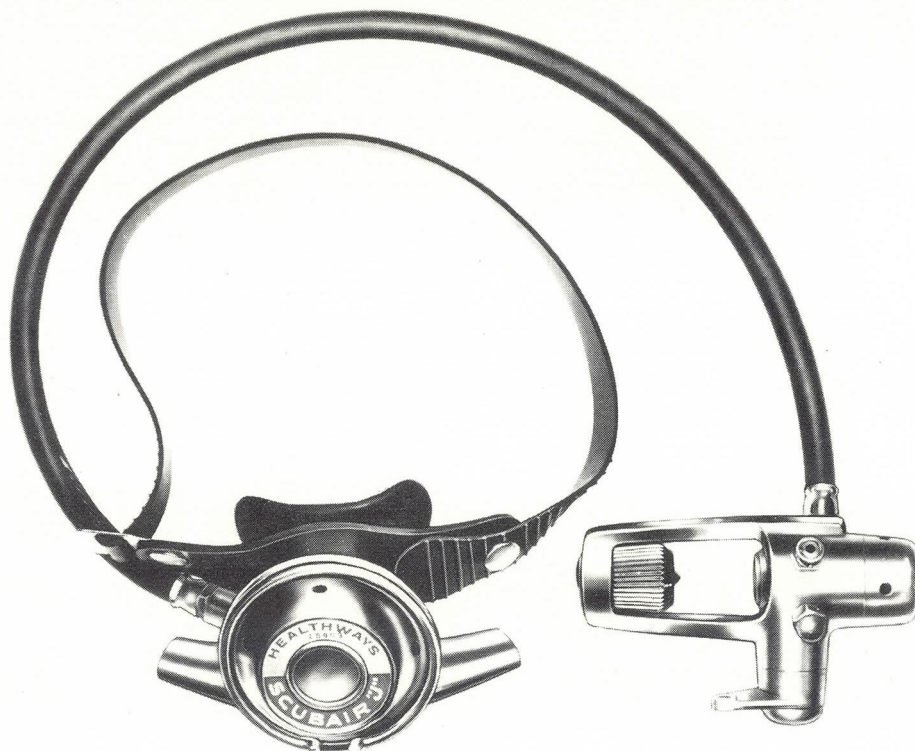

No. 1662
Scubair "J" Single Hose,
Two Stage Regulator
\$69.95

Pat. Pending

A PROFESSIONALLY ENGINEERED REGULATOR INCORPORATING A BUILT-IN SPRING LOADED CONSTANT AIR RESERVE

FIRST STAGE: The Scubair "J" first stage incorporates a spring loaded constant air reserve mechanism. This mechanism provides the diver with a 300 psi constant air reserve even though his cylinders are not equipped with reserve valves. The Scubair "J" first stage features Healthways exclusive internal yoke screw which eliminates the conventional wing nut and provides an easily operated, snag proof means of attaching the regulator—a removable high pressure plug for attaching the Submersible Scub-Air Gauge that enables the diver to know at all times how much air remains in the cylinder while diving—a removable low pressure plug that provides for the attachment of an additional second stage for training purposes. The Scubair "J" first stage is constructed of a chrome plated forged brass body, all stainless steel springs and is impervious to the elements.

SECOND STAGE: A "downstream" demand mechanism is engineered into the Scubair "J" second stage to deliver more air than any diving regulator available. This downstream demand valve automatically serves as a safety relief valve in case of an over pressure in the air supply hose. The balanced Venturi system allows the diver to breathe comfortably at any depth with no increase in inhalation effort. The Scubair "J" second stage features double exhaust valves—contoured air exhaust to prevent bubbles from obstructing the vision—recessed snag proof clearing button—nylon reinforced Neoprene diaphragm—"Quik-Klip" to facilitate inspection and maintenance—leak proof "O" ring seals for maximum safety—easy turning hose swivel—The Scubair second stage is constructed of heavy gauge chrome plated brass, all stainless steel springs and is impervious to the elements.



SCUBAIR "300"

HEALTHWAYS

Pat. Pending

No. 1663
Scubair "300" Single Hose,
Two-Stage Regulator
\$89.95

THE WORLD'S MOST OUTSTANDING REGULATOR. THE SCUBAIR "300" INCORPORATES HEALTHWAYS UNIQUE SONIC ALARM DEVICE

FIRST STAGE: For the first time in the history of self-contained diving, a regulator features an audible alarm device indicating that the air supply in the tank has reached the minimum reserve level of 300 psi. Until all the air has been exhausted, the alarm device continues to operate. With each inhalation, the loud clicking reminds the diver he is breathing reserve air. WITH THE SCUBAIR "300" THERE IS NO POSSIBILITY OF FORGETTING THIS VERY IMPORTANT AND LIFE SAVING FACT. The minimum reserve pressure of 300 psi is approximately the same as in constant air reserve valves, but with the Scubair "300" there is no necessity of manually switching to reserve air. The Scubair "300" first stage features Healthways exclusive internal yoke screw which eliminates the conventional wing nut and provides an easily operated, snag proof means of attaching the regulator—high pressure plug for attaching the Submersible Scub-Air Gauge which enables the diver to know at all times how much air remains in the cylinder while diving—a removable low pressure plug which provides for the attachment of an additional second stage for training purposes. The Scubair "300" first stage is constructed of a chrome plated forged brass body, stainless steel springs and is impervious to the elements.

SECOND STAGE: A "downstream" demand mechanism is engineered into the Scubair "300" second stage to deliver more air than any diving regulator available. This downstream demand valve automatically serves as a safety relief valve in case of an over pressure in the air supply hose. The balanced Venturi system allows the diver to breathe comfortably at any depth with no increase in inhalation effort. The Scubair "300" second stage features double exhaust valves—contoured air exhaust to prevent bubbles from obstructing vision—recessed snag proof clearing button—nylon reinforced Neoprene diaphragm—"Quik-Klip" to facilitate inspection and maintenance—leak proof "O" ring seals for maximum safety—easy turning hose swivel—The Scubair "300" second stage is constructed of heavy gauge chrome plated brass, all stainless steel springs and is impervious to the elements.

SCUBA

HEALTHWAYS



Pat. Pending

No. 1611
Scuba Double Hose,
Single-Stage Regulator
\$52.95

THE SCUBA IS THE MOST POPULAR AND DEPENDABLE REGULATOR IN ITS CLASS

The Scuba incorporates a balanced Venturi system which provides the diver with effortless breathing at any depth. A Venturi air deflector in the mouthpiece prevents involuntary loss of air, common to other single stage Venturi regulators. The Scuba features a simple, efficient, single stage mechanism—pressure balanced exhaust valve for effortless exhalation—a safety non-return mouthpiece—durable Neoprene hose and mouthpiece assembly—Healthways exclusive internal yoke screw which eliminates the conventional wing nut and provides an easily operated snag proof means of attaching the regulator—nylon reinforced Neoprene diaphragm—heavy chrome plated brass and stainless steel construction.

UNCONDITIONAL TWO YEAR GUARANTEE

TWO YEAR UNCONDITIONAL GUARANTEE FOR 1963 HEALTHWAYS REGULATORS—THE SCUBA STAR, SCUBAIR, SCUBAIR "J", SCUBAIR "300" AND THE SCUBA.

HEALTHWAYS IS THE ONLY MANUFACTURER OF SCUBA EQUIPMENT TO OFFER AN UNCONDITIONAL GUARANTEE AGAINST DEFECTS IN MATERIAL AND WORKMANSHIP FOR TWO YEARS FROM DATE OF PURCHASE. THIS TWO YEAR GUARANTEE IS THE PROOF OF THE SUPERIOR QUALITY OF HEALTHWAYS PRODUCTS. HEALTHWAYS SCUBA EQUIPMENT IS THE BEST THAT MONEY CAN BUY.

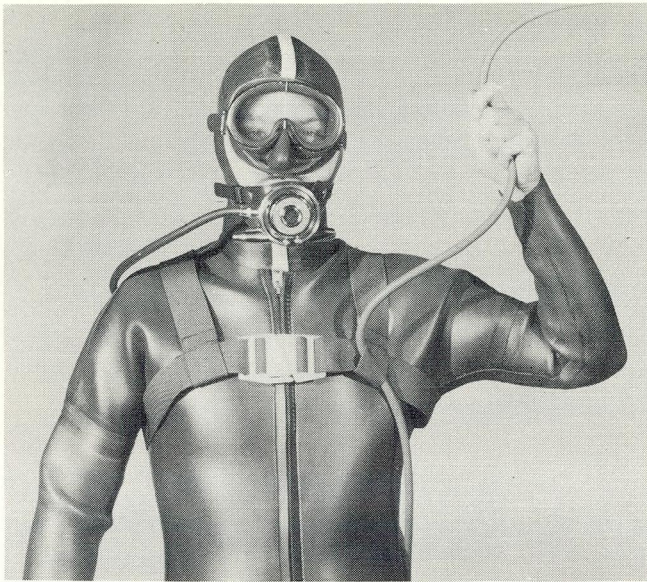

FRONT VIEW

Featured with two inch nylon webbing, which is laced in a manner that gives complete freedom of movement, comfort and adjustability. The ends of the webbing are dipped in Healthways exclusive rubber compound to prevent fraying. The harness is equipped with a newly designed nylon safety buckle.

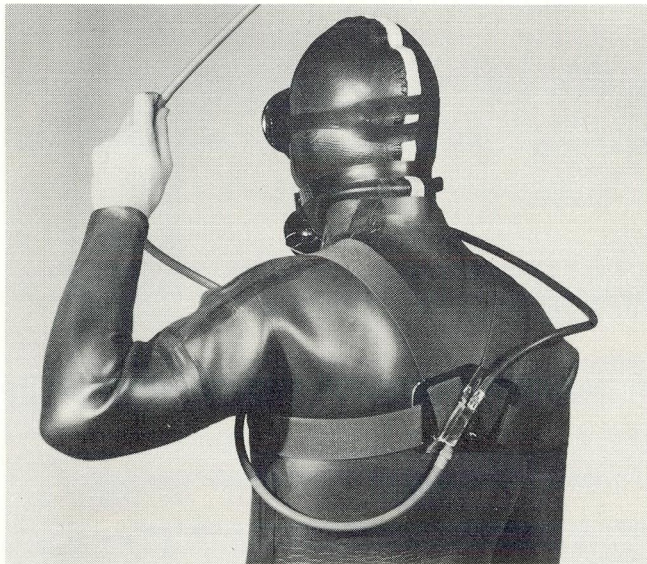

BACK VIEW

The back plate is made of heavy gauge chrome plated brass. A positive action check valve is silver braised directly on to the back plate before plating which insures that the check valve cannot be torn loose. This is important because in most instances the diver's air hose also serves as his life line. The check valve plays an important part in preventing the air in a diver's respiratory system from being forced back up the hose, should a rupture occur in the air hose at the surface. The check valve plug can be easily removed for inspection and maintenance of the stainless steel spring and check ball. The inlet of the check valve has a standard 1/4" pipe thread to which the diver can adapt any hose connection he may desire to use. The Surface Air Hook-up includes the second stage of a Scuba Star Regulator, harness and back plate with check valve.

No. 1689
SURFACE AIR HOOK-UP
\$48.00



SIDE VIEW

The surface air hose is brought under the left arm and through the front left webbing loop. This is to prevent a direct right angle pull against the check valve hose fitting, and also to keep the surface hose within reach of the diver for signalling. The Surface Air Hook-up harness is completely independent of the weight belt.

SURFACE AIR HOOK-UP

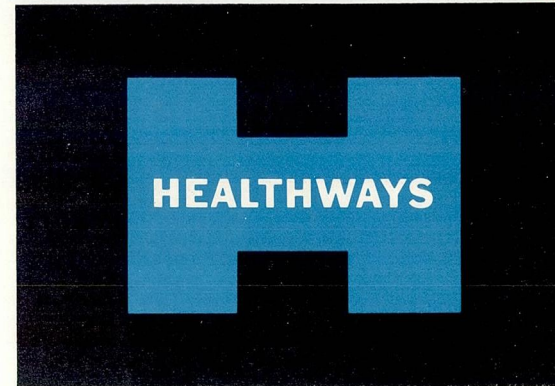

No. 1688	Surface Air Hook-up Harness	\$25.50
No. 1688-02	Check Valve Complete	9.95
No. 1688-08	2" Blue Nylon Webbing, 4 1/2 Ft. ea. (2 required)	3.00
No. 1688-09	Black Nylon Buckle (male)	.50
No. 1688-10	Black Nylon Buckle (female)	.50
No. 1688-65	Back Plate Assembly with Check Valve	25.00
No. 1664-166	Surface Air Hook-up Regulator	22.50

TANK ASSEMBLIES



PROFESSIONAL TANKS

Healthways Professional Tanks are made from Alloy Steel as required by I.C.C. (Interstate Commerce Commission) specifications. Healthways uses a Chromium-molybdenum Steel, A.I.S.I. No. 4130, which provides the strength and other physical characteristics required by the I.C.C.

There are three tests performed to prove the strength and ductility of the metal. Tensile, Crush and Hydrostatic. All cylinders are continually checked to meet Healthways exacting requirements during the production cycle to ensure proper wall thickness, threads, interior and exterior conditions. All Healthways tanks are galvanized for lasting protection against salt water, exposure and rough handling. Healthways Black Epoxy Tanks are first galvanized for double protection.

BARE TANKS

No. 0100
42 Cu. Ft. TANK,
1880 P.S.I.
GALVANIZED,
WITHOUT VALVE
\$37.95

No. 0101
Same AS No. 0100 WITH
BLACK EPOXY ON TANK
\$40.45

No. 0110
71.2 Cu. Ft. TANK,
2250 P.S.I.
GALVANIZED,
WITHOUT VALVE
\$47.95

No. 0111
SAME AS No. 0110 WITH
BLACK EPOXY ON TANK
\$50.45

See Pages 22 and 23 for Scubapak Harnesses

See Pages 25 and 26 for Tank Accessories



42 CU. FT. SINGLE TANK ASSEMBLIES

No. 0150

Includes:

No. 0100 42 CU. FT. GALVANIZED TANK
No. 1652 HIGH PRESSURE VALVE **\$43.45**

No. 0151

SAME AS No. 0150 WITH
BLACK EPOXY COATING ON TANK **\$45.45**

71.2 CU. FT. SINGLE TANK ASSEMBLIES

No. 0180

Includes:

No. 0110 71.2 CU. FT. GALVANIZED TANK
NO. 1652 HIGH PRESSURE VALVE **\$53.45**

No. 0181

SAME AS No. 0180 WITH
BLACK EPOXY COATING ON TANK **\$55.95**

42 CU. FT. DOUBLE TANK ASSEMBLIES

No. 0250

Includes:

No. 0100 42 CU. FT. GALVANIZED TANK (2)
No. 1609 HIGH PRESSURE VALVE FOR
DOUBLE TANK ASSEMBLY
No. 1619 SCUBAPAK DOUBLE TANK HARNESS
\$124.45

No. 0251

SAME AS No. 0250 WITH
BLACK EPOXY COATING ON TANKS **\$128.45**

71.2 CU. FT. DOUBLE TANK ASSEMBLIES

No. 0280

Includes:

No. 0110 71.2 CU. FT. GALVANIZED TANK (2)
No. 1609 HIGH PRESSURE VALVE FOR
DOUBLE TANK ASSEMBLY
No. 1619 SCUBAPAK DOUBLE TANK HARNESS
\$140.45

No. 0281

SAME AS No. 0280 WITH
BLACK EPOXY COATING ON TANKS **\$145.45**

No. 0160

Includes:

No. 0100 42 CU. FT. GALVANIZED TANK
No. 1654 CONSTANT AIR RESERVE VALVE **\$61.45**

No. 0161

SAME AS No. 0160 WITH
BLACK EPOXY COATING ON TANK **\$63.45**

No. 0190

Includes:

No. 0110 71.2 CU. FT. GALVANIZED TANK
NO. 1654 CONSTANT AIR RESERVE VALVE **\$71.95**

No. 0191

SAME AS No. 0190 WITH
BLACK EPOXY COATING ON TANK **\$74.45**

No. 0260

Includes:

No. 0100 42 CU. FT. GALVANIZED TANK (2)
No. 1653 CONSTANT AIR RESERVE VALVE FOR
DOUBLE TANK ASSEMBLY
No. 1619 SCUBAPAK DOUBLE TANK HARNESS
\$135.45

No. 0261

SAME AS No. 0260 WITH
BLACK EPOXY COATING ON TANKS **\$139.45**

No. 0290

Includes:

No. 0110 71.2 CU. FT. GALVANIZED TANK (2)
No. 1653 CONSTANT AIR RESERVE VALVE FOR
DOUBLE TANK ASSEMBLY
No. 1619 SCUBAPAK DOUBLE TANK HARNESS
\$145.45

No. 0291

SAME AS No. 0290 WITH
BLACK EPOXY COATING ON TANKS **\$150.45**



SCUBA AIR COMPRESSORS

The Healthways Scuba Air Compressor has been developed after years of research and thousands of hours of testing. The output and durability of the Scuba Air Compressor is incomparable and meets the most stringent requirements. The Scuba Air Compressor will fill a 71.2 cu. ft. tank from 0 to 2250 psi in approximately 13 minutes — faster and safer than any other unit available of comparable size.

The 3 stage, 2000 rpm, Scuba Air Compressor is equipped with two safety devices. One is the pressure-actuated cut off switch set at 2300 psi and the other is a pressure relief valve set at 2500 psi. It has two specially-designed filters: one for the first stage and another for the third stage. The compressor is mounted on a spring loaded frame and weighs approximately 188 lbs. The Scuba Air Compressor comes equipped with Healthways No. 1693 Filter and Gauge Combination with Bleeder Valve.

The Scuba Air Compressor is available with any one of the following power plants.

1. 7 hp Kohler gasoline engine
2. 3 hp electric motor, 110 or 220 volts, single phase
3. 3 hp electric motor, 220 or 440 volts, three phase

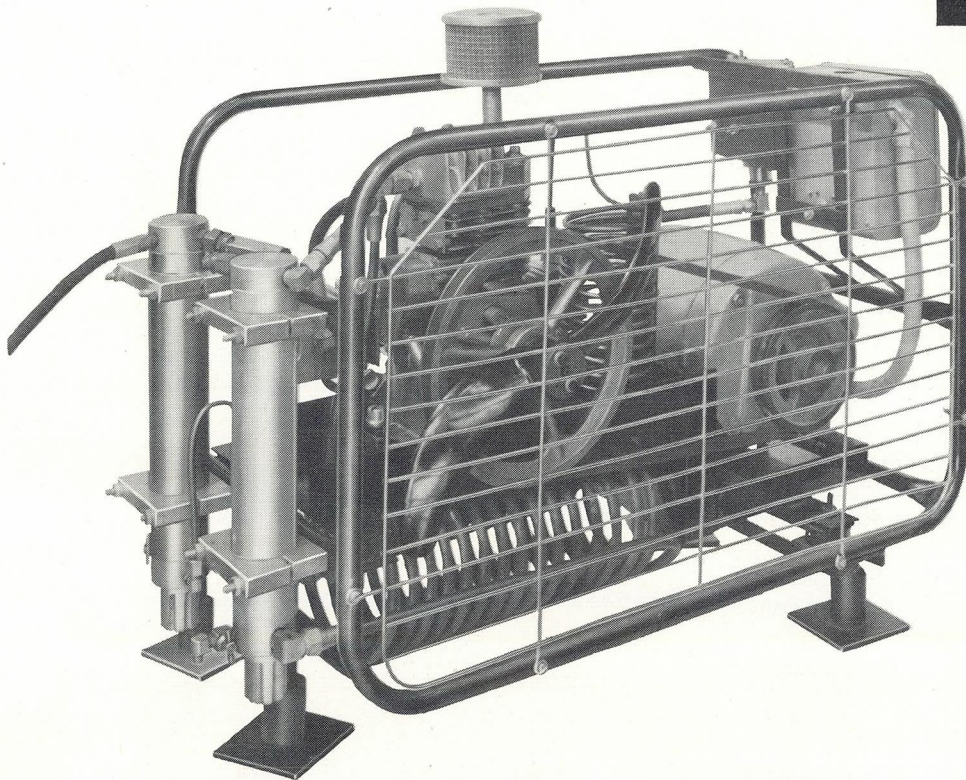

No. 1997
7 hp Kohler
Gasoline Engine

No. 1998
3 hp Electric Motor,
110 or 220 volts,
single phase

No. 1999
3 hp Electric Motor,
220 or 440 volts,
three phase

No. 1693
Filler and Gauge Combination with Bleeder Valve
For simultaneous tank refilling, pressure reading

\$17.95

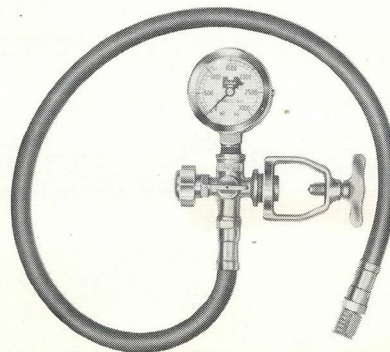

SCUBA ACCESSORIES

HEALTHWAYS

SCUBAPAK HARNESS

HEALTHWAYS

The Scubapak is made of a single sheet of specially compounded aluminum alloy that provides maximum safety, comfort and utility. A protective coating of resilient high impact Vinyl makes the back plate impervious to salt water and the elements. The Scubapak puts the tank where it should be on the diver's back. The ends of the nylon webbing are dipped in Healthways special rubber compound to prevent fraying. The Scubapak is equipped with Healthways Jet-O-Sen quick release buckle, a crotch strap that may be used at the option of the diver plus a safety release shoulder strap. The Scubapak incorporates two easy-to-carry handles, designed as an integral part of the harness, which make carrying the tank as easy as carrying a suitcase. The single tank harness features Healthways revolutionary new stainless steel "criss-cross" bands. This design provides a more secure tank attachment than the conventional two parallel band arrangement. The "criss-cross" bands incorporate an easy action thumb screw for quick assembly and removal of the Scubapak.

**No. 1443
SCUBAPACK SINGLE
TANK HARNESS
\$12.95**



**No. 1619
SCUBAPACK DOUBLE
TANK HARNESS
\$16.50**

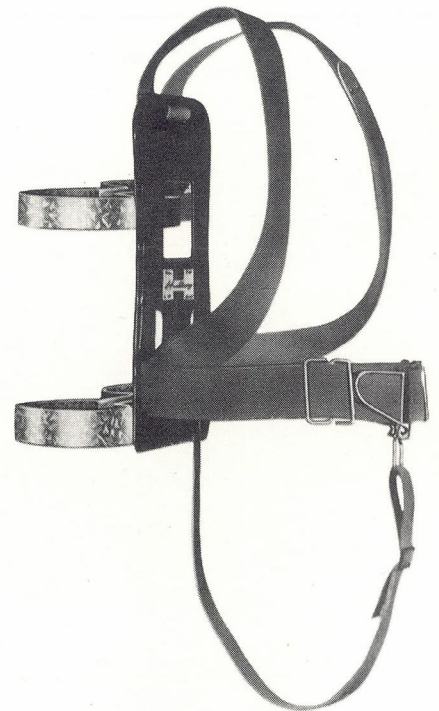

**No. 1942-03
SCUBAPACK 2" SAFETY
BUCKLE ASSEMBLY**
Stainless Steel, 4 pieces,
fits 2" to 2 1/8" Web Belts
and Scuba Harnesses.
\$1.75

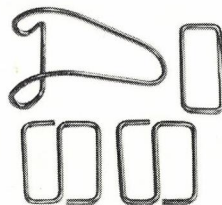

**No. 1619-11
DOUBLE TANK BANDS
\$6.30 pr.**

(Used to convert Healthways
single tank assemblies to
double tank assemblies.)



No. 1445
**CONTOUR SCUBAPAK
 SINGLE TANK HARNESS**
 \$16.95



SCUBAPAK CONTOUR HARNESS

HEALTHWAYS

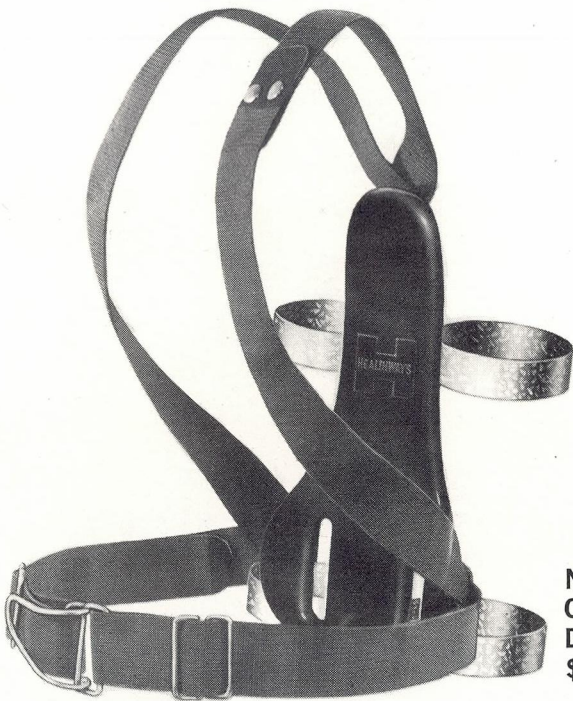

No. 1446
**CONTOUR SCUBAPAK
 DOUBLE TANK HARNESS**
 \$18.50

Healthways Deluxe Contour Scubapak incorporates all the outstanding features of the famous standard Scubapak—nylon webbing—easy-to-carry handles—continuous strap arrangement and the Jet-o-Sen quick release safety buckle. These features are incorporated without adding unnecessary bulk to achieve what a contour pack is designed to do. The Contour Scubapak is designed to eliminate large gaps in the back plate and the result is truly the most comfortable and form fitting contour pack ever developed. The Single Tank Harness features Healthways revolutionary new stainless steel single band design. This design provides a more secure tank attachment and incorporates an instant action quick release latch that allows removal of the Contour Scubapak in seconds.

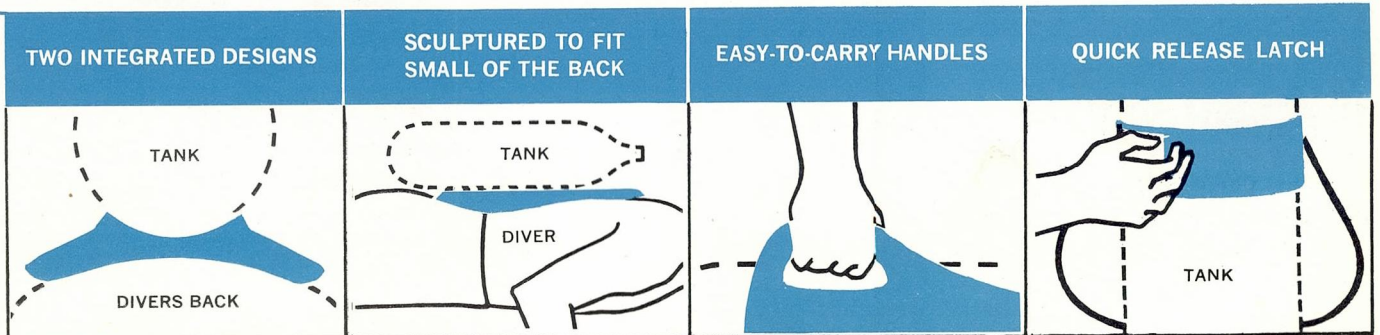

PROFESSIONAL TANK VALVES



Healthways professional valves are designed specifically for Scuba Diving and are the safest and most thoroughly engineered valves available. They are designed by professionals to meet the strict requirements of the discriminating diver. All Healthways valves contain an absolutely foolproof safety plug. (THE ONLY TYPE OF SAFETY PLUG THAT MEETS ICC REQUIREMENTS FOR ALLOWING THE 10% AIR PRESSURE OVERLOAD.) Healthways valves feature a high pressure outlet that is drilled downstream of the shutoff. This permits the diver to remove the high pressure plug and install a submersible pressure gauge while the cylinder is full of air.

See page 25 for Scuba accessories.

**No. 1652
PROFESSIONAL
HIGH PRESSURE VALVE
\$9.95**

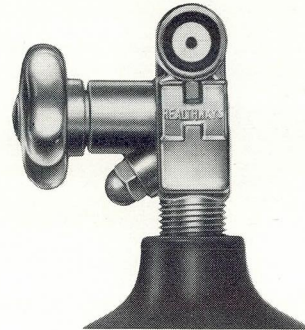

**No. 1654
PROFESSIONAL CONSTANT AIR RESERVE VALVE
\$29.95**

(Pull rod included)

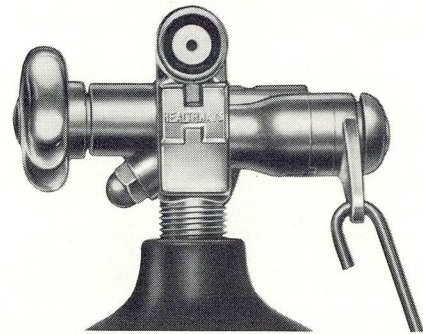

**No. 1609
PROFESSIONAL
HIGH PRESSURE VALVE FOR
DOUBLE TANK ASSEMBLY
\$29.95**

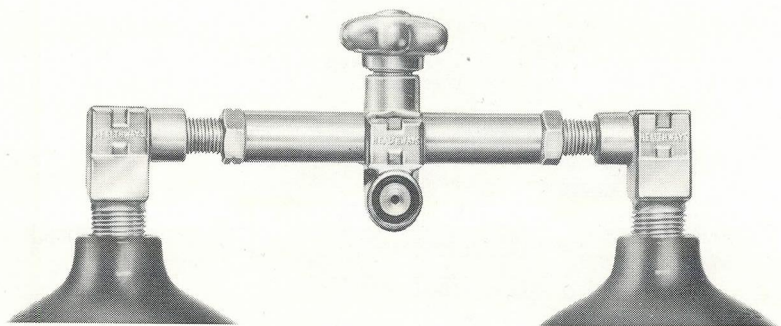

**No. 1653
PROFESSIONAL CONSTANT
AIR RESERVE VALVE FOR
DOUBLE TANK ASSEMBLY
\$49.95**

(Pull rod included)

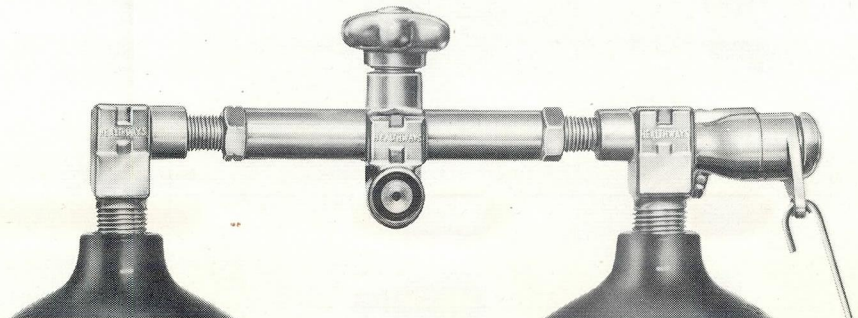



TANK PRESSURE GAUGE

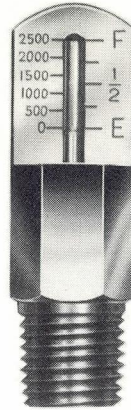

No. 1604
SUBMERSIBLE TANK PRESSURE GAUGE
\$13.95

Healthways new Submersible Tank Pressure Gauge is designed with the foolproof simplicity and rugged durability required by ardent divers. This accurate, easy-to-read gauge is leak-proof, pressure-proof and unaffected by extremely rough use. It features a flexible high pressure hose with stainless steel wire braid, BUNA liner, Neoprene outer covering and heavy-chromed brass connections.

**SCUBA
 ACCESSORIES**

HEALTHWAYS

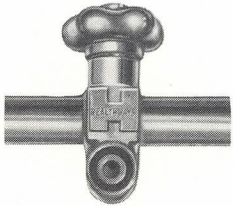

No. 1653-01
CONTROL VALVE
\$16.95

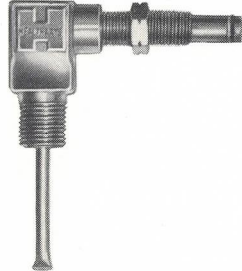

No. 1653-02
ELBOW FOR DOUBLE
TANK MANIFOLD
 Left Hand Thread
\$6.95

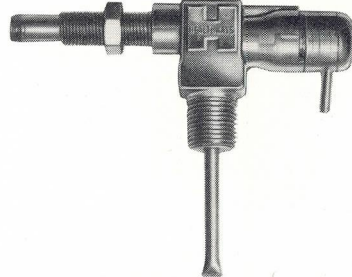

No. 1653-03
CONSTANT RESERVE
VALVE ELBOW FOR
DOUBLE TANK MANIFOLD
\$28.50

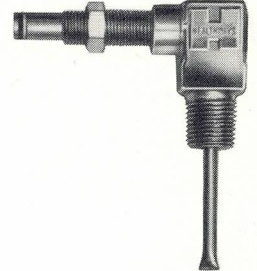

No. 1609-03
ELBOW FOR DOUBLE
TANK MANIFOLD
 Right Hand Thread
\$6.95



No. 1603
HIGH PRESSURE VALVE
\$6.95

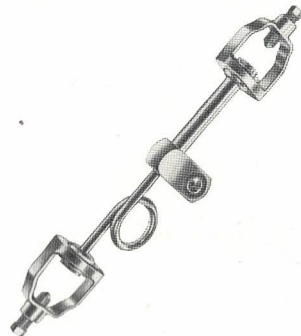

No. 1606
TWO TANK YOKE ASSEMBLY
 (standard pigtail type)
\$14.95

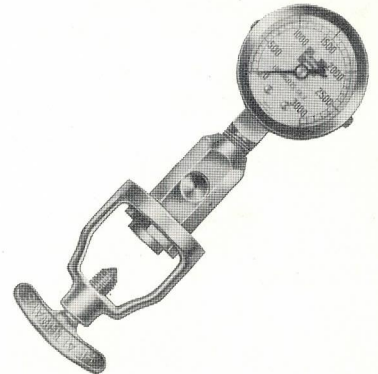

No. 1614
PRESSURE GAUGE AND
YOKE WITH BLEEDER VALVE
\$9.95

SCUBA ACCESSORIES

HEALTHWAYS

REGULATOR AND VALVE REPAIR KIT



No. 1447 REGULATOR AND VALVE REPAIR KIT

Includes regulator and valve exploded view diagrams, Healthways regulator and valve instruction book, 200 lb. test gauge, and all necessary special tools.

No. 1621 SCUBA NON-RETURN MOUTHPIECE ASSEMBLY

Includes

- No. 1621-01 Mouthpiece
- No. 1621-02 Nylon Inserts (2)
- No. 1621-03 Non-return Rubber Valve (2)
- No. 1611-47 Hose Clamps (2)
- No. 1621-05 Baffle

\$4.95

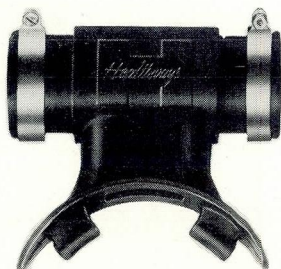

No. 1448 TANK BOOT

A slip-on tank stand to protect boat decks and swimming pools. Made of durable Zetaphin.

\$4.95



No. 1639 SCUBA HOSE ASSEMBLY

Includes

- No. 1601-01 Air Flo Hose for Scuba (2)
- No. 1621 Scuba Non-return Mouthpiece Assembly
- No. 1611-47 Hose Clamps (2)

\$8.95



No. 1696 Tank Valve Sealing Compound

(to insure leak proof seal)

\$2.75



No. 1601-01 AIR-FLO HOSE FOR SCUBA

Sold separately without clamps. Special Neoprene and gum rubber compound —patented spiral principal.

\$2.50



CRESSI SAETTA



No. 1531
SAETTA SPEAR GUN
\$24.95

Imported from Italy, Cressi guns are recognized as the finest in quality, accuracy and power. The Saetta is internally spring powered and constructed of non-corrosive material throughout. The center pistol grip provides perfect balance for exceptional accuracy and maneuverability.

SPEARFISHING GUNS

HEALTHWAYS

DOUBLETTE



No. 1520
DOUBLETTE
\$24.95

A gun with two spears — one spear powered by Arbalete — the second by an internal spring. The Doublette is rust and corrosion resistant. The Doublette is perfectly balanced for ease in underwater handling. It has a pistol grip handle with positive safety catch for Arbalete spear release and a center pistol grip with positive safety catch for spring powered spear release.

"BIG JIM" SLING SPEAR GUN



No. 1503
"BIG JIM" SLING SPEAR GUN
\$4.95

The "Big Jim" Sling Gun is modeled after the original Hawaiian design. The handle is molded of a durable rubber compound with a high impact polyvinyl core. The gum rubber sling may be adjusted by removing the knurled plastic knob. The 4 ft. spear shaft has a specially swedged point for exceptional long life.

SPEARFISHING GUNS

HEALTHWAYS

ESPADON ARBALETES

Designed by G. Beauchat, the originator of the Arbalete. Espadon Arbaletes are dependable all around spear fishing guns. Scientifically designed and balanced to float after release of the spear. They feature improved hand wrapped rubber power slings, tough high impact plastic handles, and a positive safety lever. The Espadons are corrosion and rust resistant.



No. 1509
STANDARD ESPADON
\$16.95

No. 1508
JR. ESPADON
\$14.50

No. 1507
BANTAM ESPADON
\$11.95

PECHE-SPORT ARBALETES

The original all metal, rust and corrosion resistant Arbalete. Peche-Sport Arbaletes are perfectly balanced to be weightless under water. They feature a comfortable pistol grip handle and a positive safety catch. Peche-Sport Arbaletes will float to the surface after the spear has been released.



SPEARFISHING GUNS

HEALTHWAYS



No. 1504
PECHE-SPORT JR.
\$17.50

No. 1505
PECHE-SPORT STANDARD
\$19.95

No. 1506
PECHE-SPORT DELUXE
(Center Grip)
\$27.50

SPEARHEADS AND ACCESSORIES



CRESSI SPEARHEADS

Cressi Spearheads are famous the world over for their fine quality and are interchangeable for all Cressi Spears. With the use of No. 1500-10 Adapter, Cressi Spearheads may also be used on French Arbalete spear shafts.

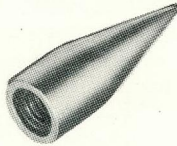

**No. 1530-01
SPEARHEAD TIP**
\$.40

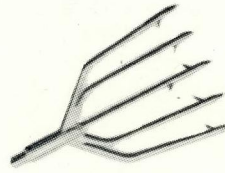

**No. 1511-02
FIVE PRONG**
\$1.75



**No. 1533-02
TWO BARB**
\$1.95



**No. 1500-10
SPEARHEAD
ADAPTER SLEEVE**
(Permits Cressi Spearheads to be used on any Peche-Sport or French Arbalete Spear shafts).
\$.75

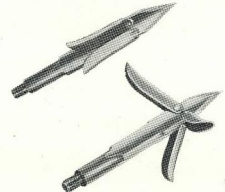

**No. 1500-06
THREE BARB
STAR**
\$4.50

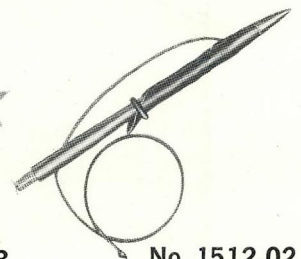

**No. 1512-02
DETACHABLE HEAD**
\$3.75

SPEARHEADS



**No. 1504-02
SINGLE BARB**
\$.98

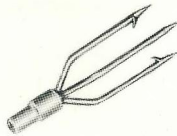

**No. 1507-02
TRI-POINT**
\$1.75



**No. 1505-02
DOUBLE BARB**
\$1.98

**No. 1513-10
ARBALETE SPEARHEAD ADAPTER**
(Permits use of all Arbalete Type Spearheads)
\$.75



NYLON LINE

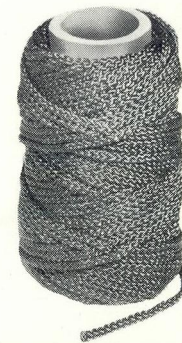

**No. 1591
NYLON LINE**
(200 lb. test, 150 ft. spool)
\$5.25

SWIMMING AIDS

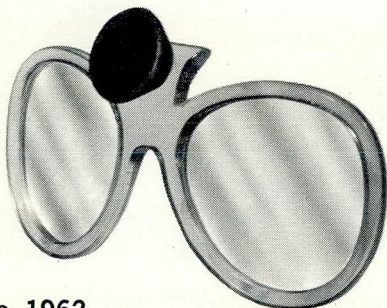

**No. 1962
PRESCRIPTION LENS HOLDER**
Fits all popular standard masks
(Through a suction cup the lens holder can be adjusted for every mask and for every vision requirement.)
\$3.95

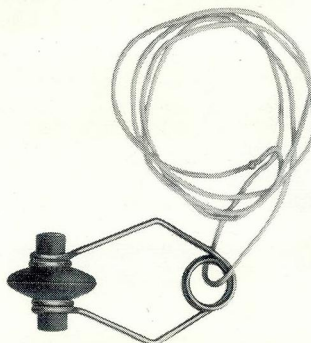

**No. 1930
CRESSI PROFESSIONAL
NOSE CLIPS**
(Made of pure gum rubber in standard sizes)
\$.50

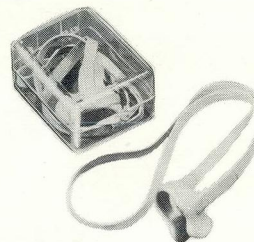

**No. 1915
Nose Clips**
(Made of pure Latex in standard sizes)
\$.50

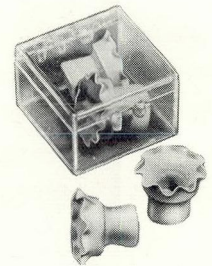

**No. 1928
EAR STOPPLES**
(assorted sizes)
\$.25

SCUBALITE

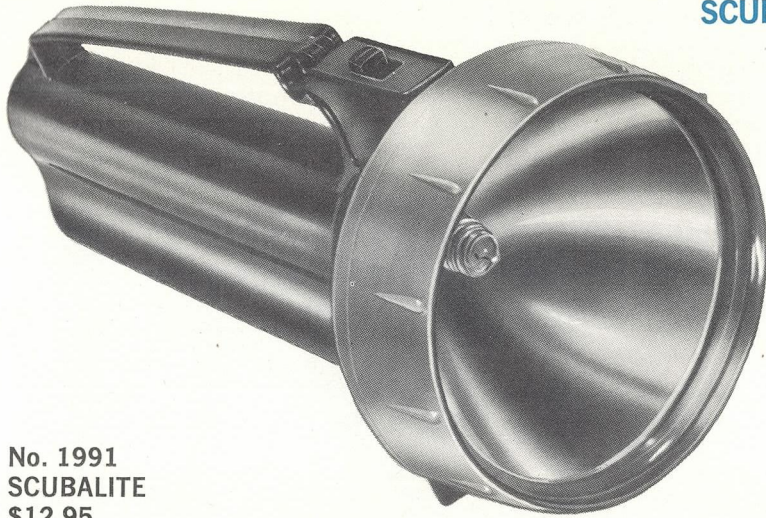

**No. 1991
SCUBALITE
\$12.95**

The Scubalite with 80,000 candle power is the most powerful diving light ever developed for Scuba divers. The floating pressure resistant, one piece body is made of high impact Marlex and features a completely water, pressure and corrosion proof switch and an easy to grip handle. The Scubalite may be used successfully to depths of over 200 ft. A simple quarter turn gives the lens a positive seal just as in the deep sea diver's helmet. (Uses 6 standard size "D" batteries, available everywhere.)

**DIVING
ACCESSORIES**

HEALTHWAYS

"BIG JIM" LEAD WEIGHT BELT

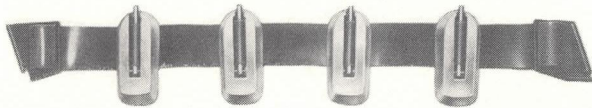

**No. 1901
12-LBS.
\$19.95**

Includes: Cat. No. 1901-04 3-lb. "Big Jim" lead weights (four); Cat. No. 1901-02 2" neoprene weight belt with black nylon safety buckle.

**No. 1901-02
"BIG JIM" WEIGHT BELT
2" neoprene belt with black nylon safety buckle.
\$3.95**

**No. 1901-03
BLACK NYLON
SAFETY BUCKLE
\$1.00**

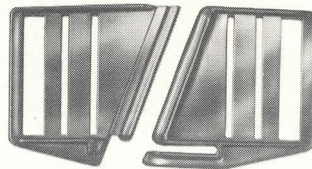

**No. 1901-01
2-LB. "BIG JIM" LEAD WEIGHT
\$2.95**

**No. 1901-04
3-LB. "BIG JIM" LEAD WEIGHT
\$3.95**

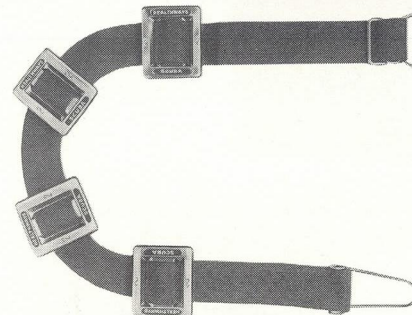
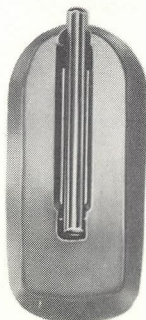

**PROFESSIONAL
LEAD WEIGHT
BELT**

**No. 1942
12 lbs.
\$14.95**

Includes 4 No. 1944-01 3-lb. "sandwich" lead weights, 1 No. 1942-02 2" Professional Web belt, with Healthway's new Jet-O-Sen quick release safety buckle that allows easy adjustment with a simple pull.

**No. 1942-02
PROFESSIONAL
WEIGHT BELT
\$2.95**

(2" Web Belt with Jet-O-Sen safety buckle assembly.)

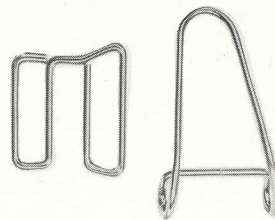

**No. 1942-04
JET-O-SEN 2" SAFETY
BUCKLE ASSEMBLY
\$1.75**

A two piece stainless steel assembly that fits 2" to 2 1/8" Web Belts and Scuba Harnesses.

**No. 1943-01
2 lb. "SANDWICH" LEAD WEIGHT
(fits 2" web belt)
\$2.00**

**No. 1944-01
3 lb. "SANDWICH" LEAD BELT
(fits 2" web belt)
\$3.00**

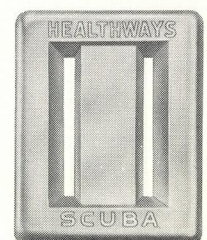

DIVING ACCESSORIES

HEALTHWAYS

ESPADON DELUXE KNIFE

An extra heavy duty, exceptionally strong, stainless steel knife with a Plastisol coated aluminum handle. The exclusive design of the sheath permits attaching to the calf of the leg — the proper positioning for skin diving knives.

No. 1985
ESPADON DELUXE
KNIFE AND SHEATH
\$9.95



ESPADON KNIFE

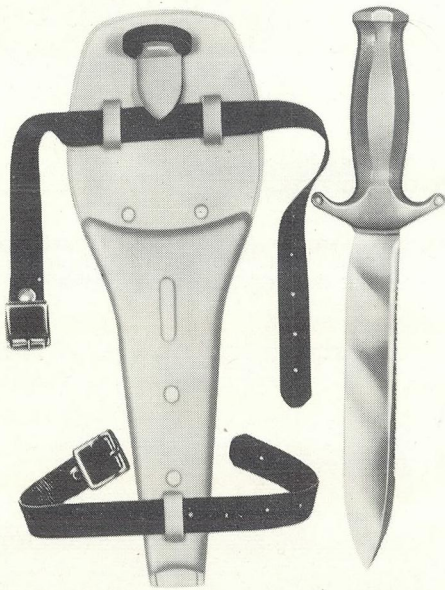

No. 1955
ESPADON KNIFE AND SHEATH
\$7.95

A heavy duty, exceptionally strong, stainless steel knife with an aluminum handle. The exclusive design of the sheath permits attaching to the calf of the leg — the proper positioning for skin diving knives.

"BIG JIM" DIVERS KNIFE

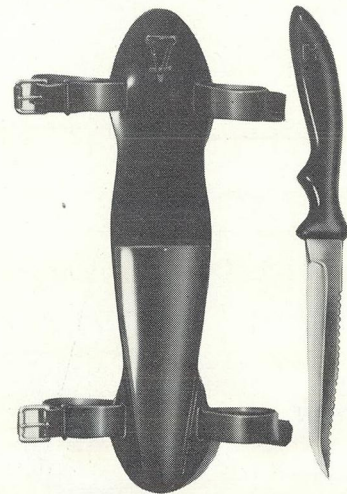

No. 1990
"BIG JIM" DIVERS KNIFE AND SHEATH
\$4.95

A compact utility knife with a stainless steel blade and polished nylon handle. The specially designed sheath may be worn on the leg, arm, weight belt, or harness.

AQUASTAR DELUXE AUTOMATIC UNDERWATER WATCH



**No. 1945
AQUASTAR DELUXE
AUTOMATIC UNDERWATER WATCH
\$79.95**

A completely new watch designed especially for the diver with these important features: automatic self winding, Bezel moving dial to record the diving time, Calendar window, luminous markings, anti-magnetic, the finest 17 jewel movement, one year guarantee. Imported from JeanRichard, Geneva, Switzerland.

DIVING ACCESSORIES

HEALTHWAYS



**No. 1946
AQUASTAR
UNDERWATER WATCH
\$34.50**

An exceptional divers watch from the world famous JeanRichard of Switzerland. The Aquastar features a 7 jewel, stem wound movement, luminous markings and is completely anti-magnetic. One year guarantee.



**No. 1947
AQUASTARLET
UNDERWATER WATCH
\$49.95**

The finest compact size watch with these outstanding features: calendar window, Bezel moving dial to record diving time, luminous markings, anti-magnetic, and a superb 17 jewel movement. One year guarantee. Imported from JeanRichard, Geneva, Switzerland.



**No. 1956
200 FT. DIVERS
DEPTH GAUGE
\$8.95**

Made with a corrosion proof, chrome plated brass housing, completely encased in rubber, and a form fitting wrist strap.



**No. 1958
200 FT. DIVERS COMBINATION
COMPASS AND DEPTH GAUGE
\$10.95**

Made with a corrosion proof, chrome plated brass housing, completely encased in rubber, and form fitting wrist strap.



**No. 1959
250 FT. AQUASTAR
PROFESSIONAL COMPASS AND
DEPTH GAUGE COMBINATION
\$14.95**

A precise compass and depth gauge combination made of heavy chrome plated brass with a curved wrist fitting housing.



**No. 1964
SUBMARINE LIQUID COMPASS
\$5.95**

DIVING SAFETY SECTION

HEALTHWAYS

AUTOMATIC DECOMPRESSION METER

With Healthways Automatic Decompression Meter there is no need to worry; you can always be sure. The precision instrument that functions automatically like an "electronic brain" — continuously memorizing repetitive and multiple depth dives. The Automatic Decompression Meter takes the guess work out of planning your dive. It records the two essential elements for each dive . . . TIME and DEPTH, automatically calculates these two factors and immediately indicates the necessary decompression time. The Automatic Decompression Meter reproduces the physiology of the body by duplicating the rate at which the nitrogen goes into and out of solution in the blood stream. Keeping an exact record of the dive just completed and of the time you spent on the surface between dives, it uses the diving time as well as the surface time to automatically calculate and prescribe the decompression time necessary on the next dive. This process of memorizing continues for 6 hours after the last dive you make. The compact unit can be worn on the arm or attached to your harness.



No. 1973
AUTOMATIC DECOMPRESSION METER
\$49.95

"BIG JIM" DIVERS FLAG/BUOY



DIVING
SAFETY SECTION

HEALTHWAYS

The "Big Jim" Divers Flag/Buoy combines the conventional divers flag and a new inflatable marker buoy into one compact and functional unit. It is inflated by means of a single, easy to operate, trouble-free plastic push-pull valve. The "Big Jim" Divers Flag/Buoy is designed with a two-inch belt and buckle assembly that is permanently sealed to the base for attaching a conventional 2-lb. weight. This weight insures that the flag floats upright at all times so that passing boats and other divers in the area can easily see it. A brass grommet is located near the water line which ensures towing and anchoring without upsetting the flag. The "Big Jim" Divers Flag/Buoy when deflated can be folded into the size of a handkerchief and be carried in a pocket or similar small place.

Designed by "Big Jim" Christiansen

No. 1981
"BIG JIM" DIVERS FLAG/BUOY
\$3.95

DIVING SAFETY SECTION



UTILITY BAG/SAFETY FLOAT

The most practical safety float ever designed. It combines an inflatable float, for use as a divers base and a zippered utility bag for storing gear. Made of heavy duty vinyl, 48" x 30".

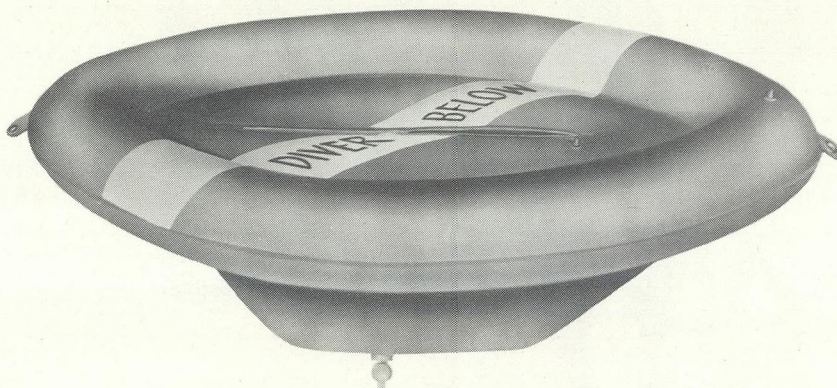

No. 1992
DIVERS UTILITY BAG/SAFETY FLOAT
\$6.95

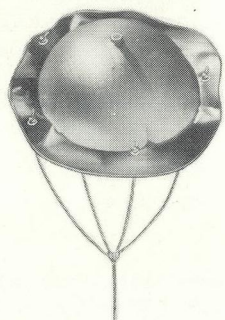

No. 1987
MARKER BUOY
\$1.95

A unique inflatable marker float. It can be used as a safety float in a pool or as a marker for the boating enthusiast or skin diver.

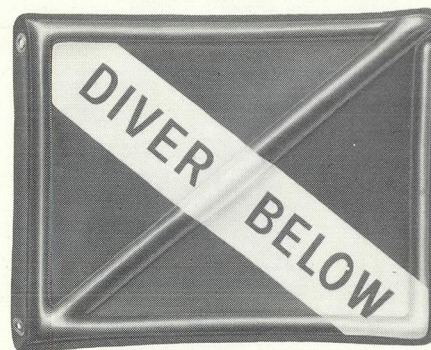

No. 1969
INFLATABLE DIVERS FLAG
\$1.95

The most sensational divers safety flag ever devised. Made of heavy duty Virgin Vinyl with an inflatable rim that allows it to remain unfurled at all times.



No. 1912
"UNDERWATER SAFETY"
by E. R. Cross
\$1.00

DEPTH IN FEET	TIME OF DIVE IN MINUTES		DECOMPRESSION TIME AT 10 FEET
	NOT REQUIRED	REQUIRED	
50	78	120	2
60	55	75	2
70	43	60	4
80	35	50	6
90	30	45	6
100	25	40	12
120	18	30	11
140	12	15	4
160	8	15	9
180	5	10	7
200	4	8	25

IF THE TIME IS EXCEEDED USE NEXT COLUMN

FOR DEPTH AND TIME EXCEEDING THIS TABLE USE HEALTHWAYS' DECOMPRESSION METER

No. 1719
DECOMPRESSION
TABLE DECAL
\$1.00

Healthways Decompression Table Decal gives you the maximum diving time at a given depth with no decompression and maximum diving time with decompression only at 10 feet. Healthways Decompression Table Decal can be easily attached to the arm of any Neoprene diving suit.

SCUBA-VEST LIFE JACKET



DIVING
SAFETY SECTION

HEALTHWAYS

No. 1988
SCUBA-VEST LIFE JACKET
\$9.95

Designed by Jim Christiansen, one of America's foremost advocates of diving safety. The Scuba-Vest is made of specially prepared material, the inside of which is completely saturated with a specially compounded leak proof and corrosion proof heavy coating. The Scuba-Vest is engineered to float an unconscious or resting diver in a "face-up" position. Experience has shown that although the Scuba-Vest is primarily a safety device it can be utilized for "that long swim back to the boat."

The Scuba-Vest is reversible. One side is professional black, the other side is officially approved International Orange, the most vivid of colors for diving safety. In an emergency the diver wearing the black side out can easily reverse the vest to show the orange side out for easy identification. The Scuba-Vest is inflated by means of a "Squeeze Grip" detonator containing an oversized cadmium plated CO₂ cartridge. The re-usable detonator can be easily removed and a new CO₂ cartridge installed ready for instant re-use.

No. 1988-02
DETONATOR
\$3.00

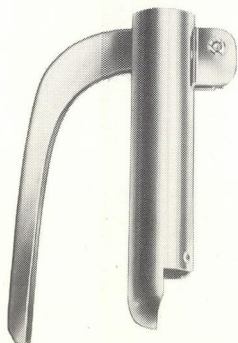

No. 1989
CO₂ CARTRIDGE
(Package of 6)
\$3.00

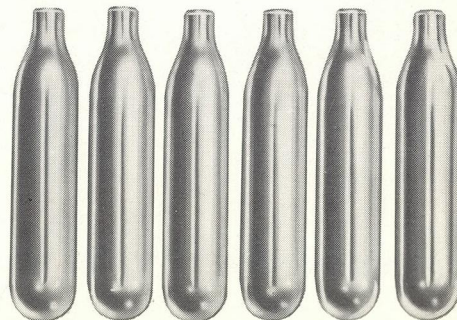

SUBMARINES

HEALTHWAYS

Healthways Submarines are the ultimate in underwater transportation for the SCUBA diver. They are the result of many years of research and development by Healthways and their Italian manufacturer C.O.S.M.O.S.

Healthways Two-Man Submarines are constructed of heavy duty fiberglass and special aluminum alloy metalwork. They are 14 feet long with a 32-inch beam and weigh approximately 500 lbs. The Submarine can be easily moved to and from the water with four divers by the two removable carrying bars.

Healthways Two-Man Submarines are controlled by an aircraft type control stick. To "dive" the pilot pushes the control stick forward, and to surface, the pilot pulls the control stick back.

Standard Equipment on Healthways Two-Man Submarines include:

- 4 Standard 12 Volt Batteries that power the Submarine for a minimum of two hours and can be recharged at any service station.
- A 48 Volt Electric Motor of 1.8 HP, 3400 RPM equipped with a 5-1 reduction gear. The motor is operated by a switch that provides two speeds forward and two speeds reverse.
- Built in Depth Gauge and Compass.
- Lead ballast to maintain an even keel.
- Built-in compressed air tank for buoyancy adjustment.

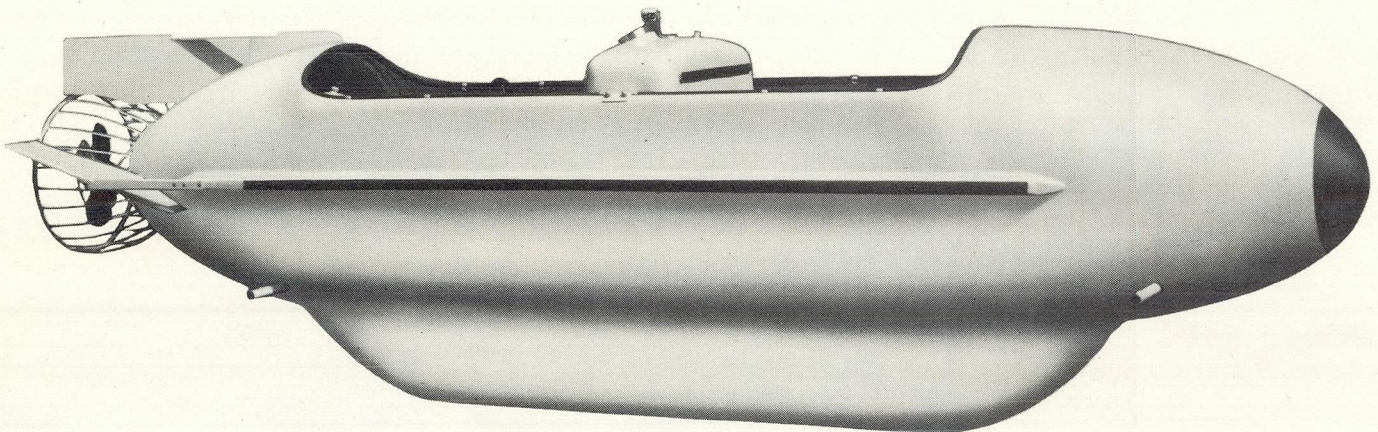

FOR YOUR SUBMARINE NEEDS WRITE TO HEALTHWAYS, P.O. Box 61061, Los Angeles 61, California

POSEIDON SUPER BOAT

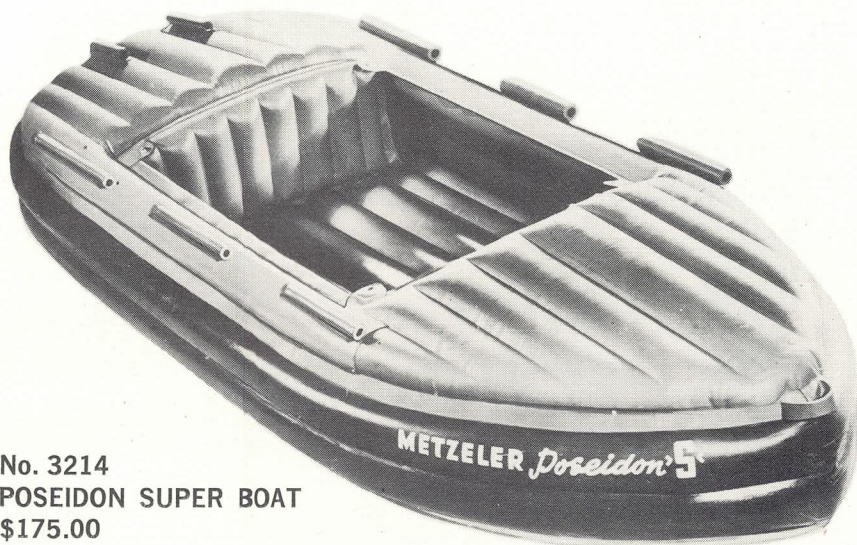

No. 3214
POSEIDON SUPER BOAT
\$175.00

INFLATABLE BOATS

HEALTHWAYS

A two or three seater boat made of extra heavy duty canvas, completely rubberized inside and out. The ideal family and sports boat. Can be used with an outboard motor. The Poseidon folds into a compact shoulder carrying bag. It is inflatable in minutes to 50" wide, 112" long and 24" deep.

INKA BOAT



No. 3213
INKA BOAT
\$165.00

An extra heavy duty canvas boat, completely rubberized inside and out. An excellent boat for the hunter, skin diver, or as an auxiliary boat for the yachtsman. Can be used with an outboard motor. The Inka Boat folds into a compact, shoulder carrying bag. It inflates in minutes to 50" wide, 110" long, and 14" deep.

UNDERWATER EXPOSURE SUITS

HEALTHWAYS

CORONADO CUSTOM CONTOUR NEOPRENE SUIT



2 Piece Suit made of 3/16" or 1/4" heavy duty, high stretch, double skin foam Neoprene that incorporates these outstanding features: All stress points eliminated—No side seam at hips—Double duty snap patch to reinforce suit at greatest stress point—Cross seam at arm pit eliminated—Adjustable bib for greater neck warmth—The exclusive contour design incorporates a fly zipper in the pants and a heavy duty, giant zipper on the shirt front.

3/16"			1/4"		
No.	Size	Price	No.	Size	Price
0500	X-Small	\$39.50	0505	X-Small	\$42.50
0501	Small	39.50	0506	Small	42.50
0502	Medium	39.50	0507	Medium	42.50
0503	Large	39.50	0508	Large	42.50
0504	X-Large	39.50	0509	X-Large	42.50

THERMO-VEST

An important addition to your Neoprene suit for cold water dives. The contoured Thermo-Vest offers a double thickness of protective insulation in the upper body, where it is needed most.

0620
Small
\$6.75

0621
Medium
6.75

0622
Large
6.75



CORONADO DELUXE "NYLO-FOAM" NEOPRENE SUIT



2 Piece Suit made of 3/16" or 1/4" heavy duty, high stretch, double skin foam Neoprene with durable "four way stretch" nylon lining for added strength and tear resistance. The nylon is molded to the Neoprene by Healthways exclusive "heat cure" process forming a permanent bond. Healthways "Nylo-Foam" suits feature stripping on the inside for maximum seam strength. The exclusive "easy-to-put-on" design incorporates a fly zipper in the pants and a heavy duty, giant zipper in the shirt.

3/16"			1/4"		
No.	Size	Price	No.	Size	Price
0520	X-Small	\$58.50	0525	X-Small	\$61.50
0521	Small	58.50	0526	Small	61.50
0522	Medium	58.50	0527	Medium	61.50
0523	Large	58.50	0528	Large	61.50
0524	X-Large	58.50	0529	X-Large	61.50

"NYLO-FOAM" BOOTS

Made of heavy duty foam Neoprene with "four way stretch" nylon lining. The inside lining allows the boots to be put on and removed easily.



No.	Shoe Size	Price
0710	5-7	\$6.95
0711	7-9	6.95
0712	9-11	6.95
0713	11-13	6.95

SIZE CHART FOR ALL HEALTHWAYS SUITS

MEN'S SUITS

	Extra Small	Small	Medium	Large	Extra Large
CHEST	31"-33"	34"-36"	37"-39"	40"-42"	43"-46"
WAIST	24"-26"	27"-29"	30"-32"	33"-35"	36"-38"
HEIGHT	5'2"-5'7"	5'5"-5'9"	5'7"-6'0"	5'10"-6'2"	6'0"-6'4"

WOMEN'S SUITS

	Extra Small	Small	Medium	Large	Extra Large
DRESS/SIZE	5-6	7-8	11-12	15-16	32-34
DRESS/SIZE		9-10	13-14	17-18	

AQUAFEMME "NYLO-FOAM" NEOPRENE SUIT

2 Piece suit made of 3/16" heavy duty, high stretch, double skin foam Neoprene with durable "four way stretch" nylon lining for added strength and tear resistance. The nylon is molded to the Neoprene by Healthways exclusive "heat cure" process to form a permanent bond. Aquafemme "Nylo-Foam" suits feature: Custom form fitting design—Stripping on the inside for maximum seam strength—"Easy-to-put-on" design—Heavy duty giant zipper in shirt front.



3/16"

No.	Size	Price
0530	X-Small	\$56.50
0531	Small	56.50
0532	Medium	56.50
0533	Large	56.50
0534	X-Large	56.50

UNDERWATER EXPOSURE SUITS



HEALTHWAYS

BALBOA AND AQUAFEMME NEOPRENE JACKETS

An ideal jacket for the skin diver, surfer or water skier. Healthways form fitting jackets are made of 3/16" heavy duty, high stretch, double skin Neoprene with a giant zipper. The Aquafemme's distinctive "waffle" design provides even stretch distribution for maximum comfort.



BALBOA

No.	Size	Price
0600	X-Small	\$22.50
0601	Small	22.50
0602	Medium	22.50
0603	Large	22.50
0604	X-Large	22.50

AQUAFEMME

No.	Size	Price
0610	X-Small	\$19.50
0611	Small	19.50
0612	Medium	19.50
0613	Large	19.50
0614	X-Large	19.50

GLOVES

Made of heavy duty foam Neoprene. They provide maximum finger dexterity and feature a heavy duty zipper for ease in putting on and removing the gloves.



No.	Size	Price
0700	Small	\$6.50
0701	Medium	6.50
0702	Large	6.50

"NYLO-FOAM" HOOD

Made of heavy duty foam Neoprene with "four way stretch" nylon lining on the inside. The extra long, contour design allows the hood to be worn inside the suit to form a tight seal and eliminate the exchange of water.

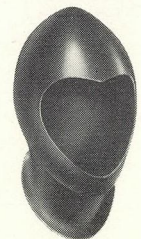

No. 0720
Small
\$5.95

No. 0721
Medium
\$5.95

No. 0722
Large
\$5.95



No. 1798
**BLACK MAGIC
FOAM NEOPRENE
CEMENT**
\$1.25



No. 1791
**RUBBER
DUST**
(Concentrated Powdered
Hydrous Silicate of Mag-
nesium) \$.60

No. 1794
**CORONADO
NEOPRENE
REPAIR KIT**
\$2.50

No. 1795
**CORONADO "NYLO-
FOAM" REPAIR KIT**
\$2.50

LLOYD BRIDGES' SEA HUNT



No. 7500
SEA HUNT POINT OF PURCHASE DISPLAY
\$549.90 Retail Value

Contains

- 6 7520 Sea Hunt Jr. Masks
- 12 7521 Sea Hunt Bantam Masks
- 12 7522 Sea Hunt Sr. Masks
- 12 7523 Sea Hunt "Clear-Ease" Masks
- 6 pr 7560 Sea Hunt Jr. Fins, Size 2-3
- 6 pr 7561 Sea Hunt Jr. Fins, Size 3-4
- 12 pr 7562 Sea Hunt Jr. Fins, Size 4-5
- 6 pr 7570 Sea Hunt Fins, Adjustable to Size 6
- 6 pr 7571 Sea Hunt Fins, Size 4-8
- 6 pr 7572 Sea Hunt Fins, Size 8-13
- 24 7605 Sea Hunt Professional Snorkel
- 6 7610 Sea Hunt Bantam Arbalete
- 12 7615 Sea Hunt Nose Clips
- 6 7620 "Mask and Flippers", Books

SEA HUNT POINT OF PURCHASE DISPLAY

The Sea Hunt Point of Purchase Display is professionally designed to provide a complete skin diving department in one unit. Each of the items chosen for the Sea Hunt line is personally endorsed by Lloyd Bridges. An autographed photo of Lloyd is prominently displayed on the attractive rack sign as well as the unit cartons. The colorful display panel holds each item and shows suggested retail price. The sturdy Unichrome plated wire rack is scientifically engineered to provide a maximum display in a minimum amount of space.



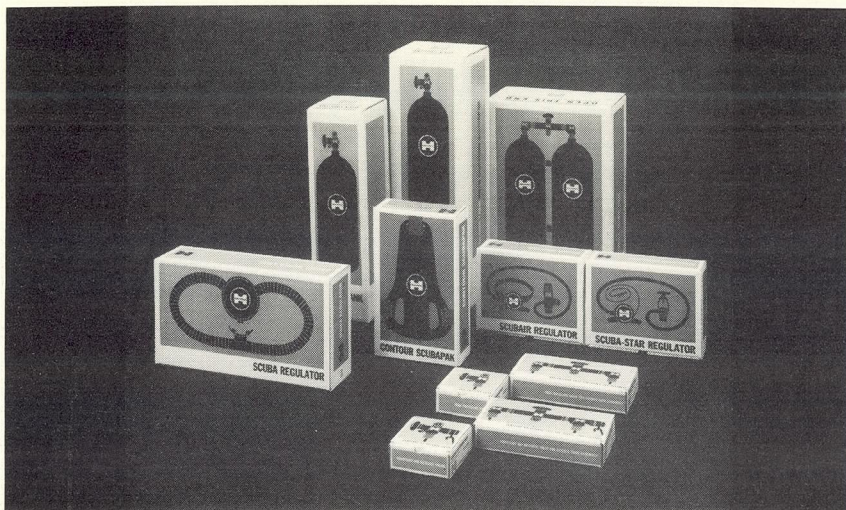

SALES ORGANIZATION

Healthways revolutionary products are presented in sales inviting packages that have won more national awards than any other sporting goods manufacturer. The packages are presented in bold, bright colors which permit instant recognition of contents. They are ideal for the construction of Point of Purchase Displays, window trimming, etc. Healthways also assists you with unparalleled dealer support by national advertising, radio, television, point of purchase and advertising displays.

• HEALTHWAYS SALES REPRESENTATIVES •

LOS ANGELES GENERAL OFFICE

RAYMOND L. BANDY
Assistant to the
General Sales Manager
P.O. Box 61061
Los Angeles 61, Calif.

RANDOLPH K. STONE
Vice President and
General Sales Manager
P.O. Box 61061
Los Angeles 61, California

CHARLES R. VICTORY
Advertising
P.O. Box 61061
Los Angeles 61, Calif.

JOEL SHERMAN
Manager Customer Service
P.O. Box 61061
Los Angeles 61, Calif.

W. G. ACTON
Customer Service
P.O. Box 61061
Los Angeles 61, Calif.

WESTERN REGION

ROBERT CARROLL
P.O. Box 61061
Los Angeles 61, Calif.

M. J. McALEECE
Western Sales Supervisor
P.O. Box 61061
Los Angeles 61, Calif.

C. W. McNUTT
6649 Vigo Drive
San Diego 15, Calif.

DAVE JOHANSON
433 156th S.E.
Bellevue, Washington

D. MELVILLE CARR
1206 Waimanu Street
Honolulu 14, Hawaii

MIDWEST REGION

CHARLES MILLER, JR.
10045 West Pacific Ave.
Franklin Park, Illinois

FLOYD ERHARD
Midwest Sales Manager
10045 West Pacific Ave.
Franklin Park, Illinois

GEORGE YOUMANS
4216 Riley Street
Houston 5, Texas

FRANK BROWN
Southwestern Sales Manager
4904 Welford Drive
Bellaire, Texas

JAMES LYONS
334 South Main
Jonesboro, Arkansas

STEVE HOFFMAN
10045 West Pacific Ave.
Franklin Park, Illinois

LEE ATCHISON
1506 Scott Place
Independence, Missouri

EASTERN REGION

STAN ARMUS
160 East Place
East Meadow, L.I., New York

ART SPECTOR
P.O. Box 94
Newtown, Connecticut

HERMAN MANCINI
8000 National Highway
Pennsauken, New Jersey

CHARLES MILLER, SR.
6405 Cherry Tree Lane
Atlanta, Georgia

TONY ANTONUCCI
8000 National Highway
Pennsauken, New Jersey

JOEY RICHMAN
4872 Lacombe Avenue
Montreal, Quebec, Canada

HEALTHWAYS WAREHOUSES: LOS ANGELES • FRANKLIN PARK, ILLINOIS • PENNSAUKEN, NEW JERSEY
TORONTO, ONTARIO, CANADA

SKIN AND SCUBA DIVING EQUIPMENT

WEIGHT LIFTING & EXERCISING EQUIPMENT

SURF, BEACH & CAMPING AIR MATTRESSES

GOLF ACCESSORIES

SPORT & TARGET PISTOLS

WATER SKIS

WOMEN'S & JUNIORS' EXERCISING EQUIPMENT



Los Angeles
P. O. Box 61061
Los Angeles 61, California

Chicago
10045 W. Pacific Ave.
Franklin Park, Illinois

Pennsauken
8000 National Highway
Pennsauken, New Jersey

Toronto
4 Bestobell Road
Toronto, Ontario, Canada