

Dacor Valves

are fully guaranteed for accuracy, dependability and service free operation

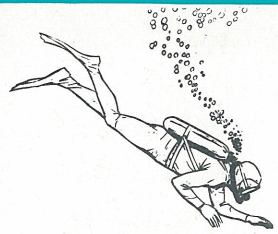

"LOW BOY"
Spring loaded reserve valve. Bright chrome finish. Large round knurled shut-off knob. 300 P.S.I. reserve. New simplified design for accuracy and service free operation.
JV-1 \$29.50

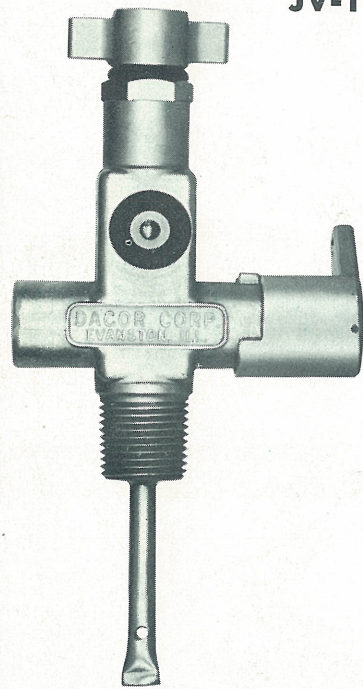

DEPTH COMPENSATING RESERVE VALVE
Provides more reserve air at greater depths. Set for 300 P.S.I. reserve. Satin Chrome.
RV-1 \$29.50

J TYPE SPRING LOADED VALVE
Same general appearance as Model RV-1. Positive shut-off when air supply is down to 300 P.S.I. Satin Chrome plated.
JV-1S \$29.50



FOR CHECKING TANK PRESSURE

EXCLUSIVE DESIGN By DACOR

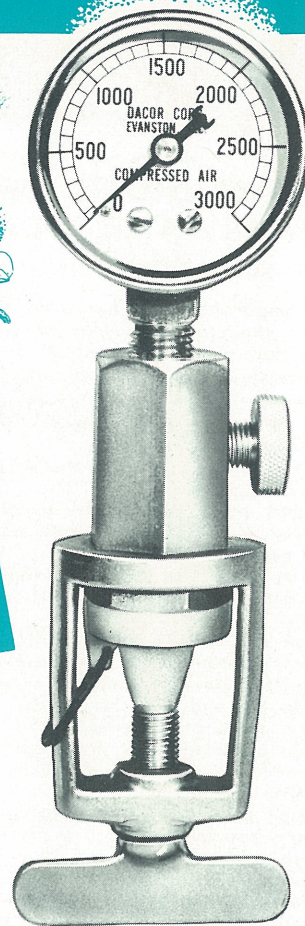

DELUXE PRESSURE GAUGE PG-C \$11.95
All brass construction, satin chrome plated. Body machined from solid brass bar stock. Forged yoke and screw. Large knurled relief screw for easy turning. Yoke swivels, enabling gauge to be turned for reading.

PRESSURE GAUGE-PG-1 \$9.95
Same as above, except brass finish and without dust cap.



STANDARD VALVE (No Reserve)
Rugged brass construction
SV-1 \$7.95

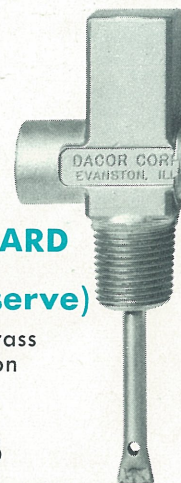

DOUBLE TANK VALVE
Spring loaded. Heavy brass construction. Satin Chrome plated. Set for 500 P.S.I.
JV-2 \$46.50

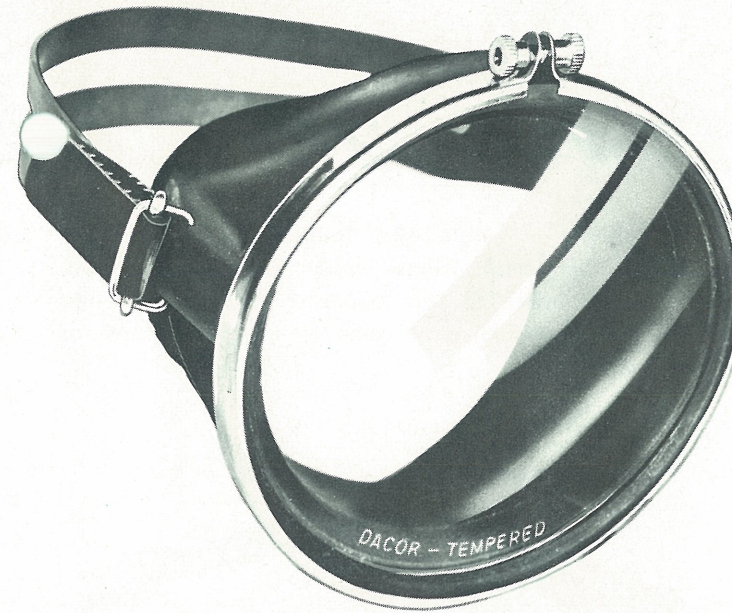
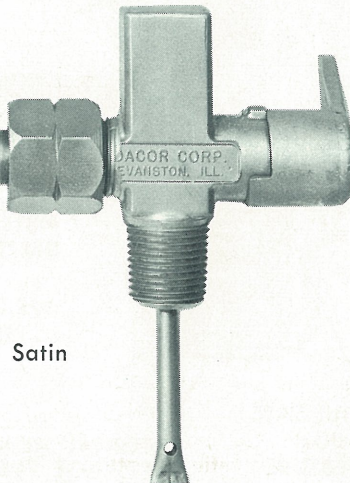
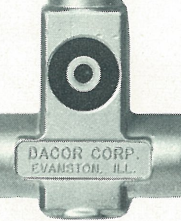

MASK-DM-10 \$4.95
Slanted design for greater visibility. Tempered safety lens. Extremely comfortable face seal, designed to prevent leakage. Stainless steel retaining ring. Made of highest quality blue or black rubber. Easy to equalize by pressing mask towards face, or press up on soft rubber to nostrils.

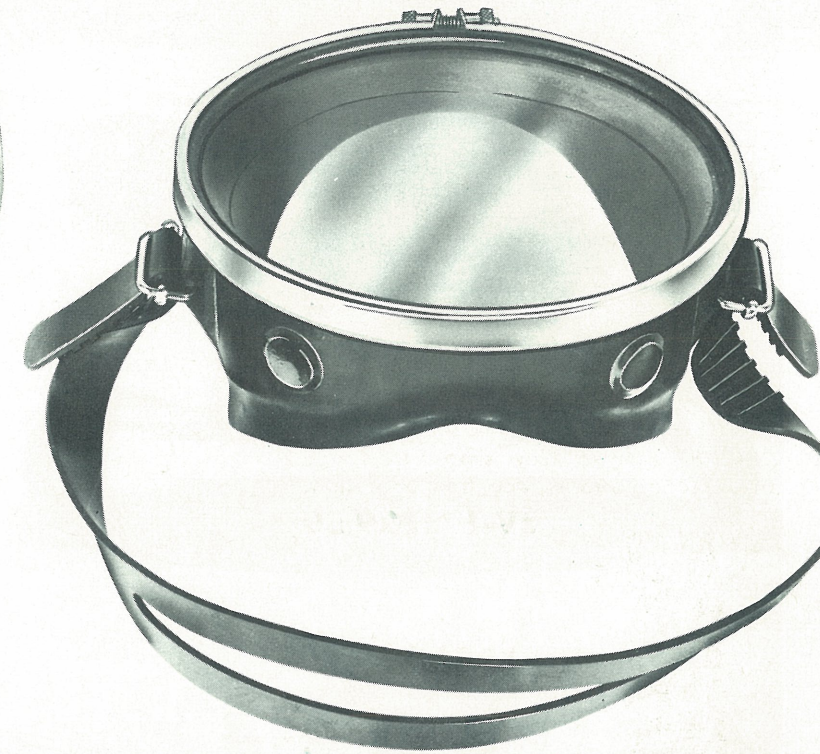

MASK-DM-11 \$5.95
Same design as Model DM-10 with two clearing valves for fast and easy clearing of water from either side. Exclusive Dacor design.

DACOR — NO COMPROMISE IN QUALITY OR FEATURES FOR PRICE

THE WORLD'S MOST POPULAR TYPE SNORKEL

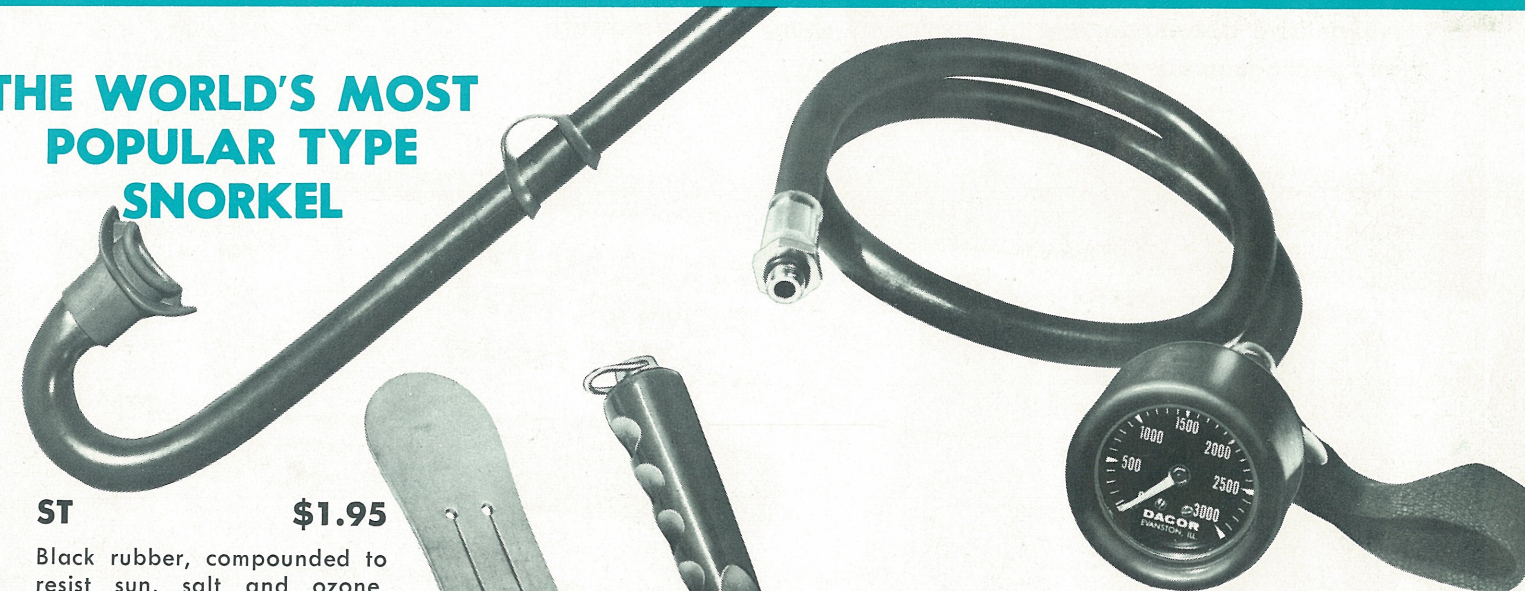

ST \$1.95
Black rubber, compounded to resist sun, salt and ozone. Odorless and tasteless. Molded mouthpiece which retains shape, is the world's most comfortable.

KNIFE— Model DK \$4.95
Heavy duty stainless steel blade with serrated edge for sawing. Finger grip cork handle with wide guard. Complete with heavy plastic sheath.

DART PRESSURE GAUGE Model DPG \$20.00
Gauge is attached to harness for easy reading of tank pressures at all times. Rubber covered case for protection against damage. Attached to 1st stage connector.—10,000 P.S.I. high pressure hose.



Dacor Safety Float

The Safety Float that Tops Them All!

Available in single and double models. Colors—black or yellow. Trigger action for easier inflation. Bleeder hole for fast deflation. Special cartridge retainer permits easy removal or replacement of cartridge.

Single _____ \$ 7.95
Double _____ \$12.95

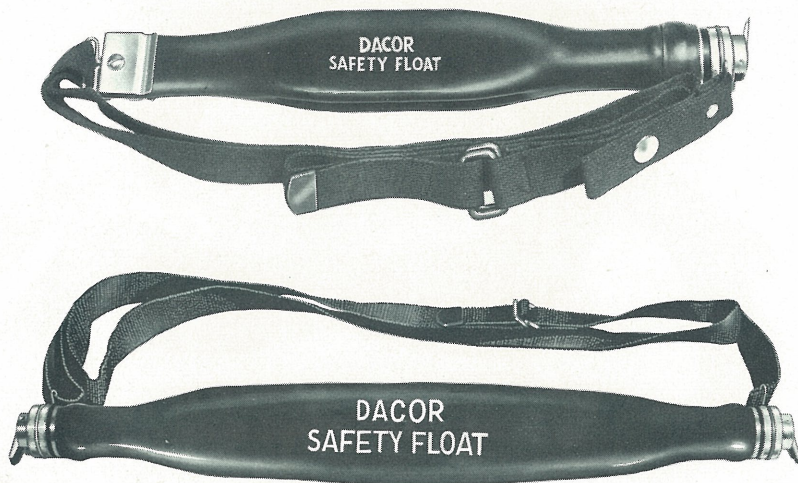

USES

- Safety device for skin divers
- Marker buoy
- Swimming aid
- Emergency float for boaters

The DACOR SAFETY FLOAT uses low cost seltzer cartridges* inexpensive and obtainable at any hobby shop, drug, hardware, and package goods stores.

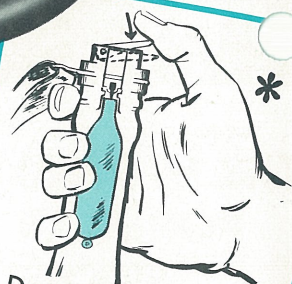

Depress lever and release for instant inflation

"STREAMLINE" POWER FINS ... THEY FLOAT!

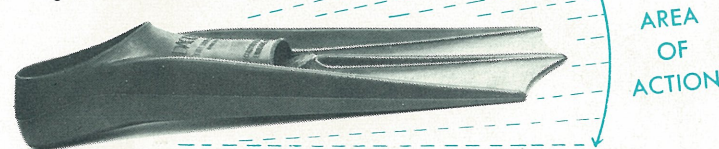

AREA OF ACTION

Designed like a shoe for maximum comfort and snug fit. No better quality rubber can be molded into fins—"Shiny" black color will retain "New Look" longer. Designed for excellent propulsion with the least possible muscle fatigue. High pointed rails give more thrust on blade.

FOR APPEARANCE, QUALITY AND PERFORMANCE, WE INVITE COMPARISON

Complete foot protection. Open toe permits movement of foot to proper position for greatest comfort.
Size 5-7 \$10.95
Size 8-9 \$10.95
Size 9-10 \$11.95
Size 10-13 \$12.95



A COMPLETE NEW LINE—FOR SPORT DIVERS AND PROFESSIONALS

One Quality...

FOR SAFETY, PERFORMANCE, DEPENDABILITY—MADE TO LAST A LIFETIME

"THE SWEETHEART OF THE UNDERWATER WORLD"

DART SINGLE HOSE REGULATOR

The incomparable Dart has been tested in pressure chamber at depths to 7000 feet with perfect performance at all depths.

- All exterior parts are heavy gauge brass, coppered, nicked and chrome plated.
- The smoothest and easiest breathing regulator conceivable
- Large "Piston Action" diaphragm for easiest operation
- Demand valve lever operates on Teflon bearing for less friction and more uniform action
- Entirely new "comfort" mouthpiece designed exclusively for single hose application
- Design and weight of regulator with the proper positioning of the mouthpiece is so well balanced that the feeling of weight or pull on the mouth is completely eliminated under water
- Rubber exhaust tubes discharge exhaled air farther to rear and afford clearer visibility
- Clearing button for fast clearing of regulator when needed
- Air gauge connector
- Air compressor connector
- So well designed and of such high quality materials that you may save the entire purchase price in repair expense alone. Safety not sacrificed for price

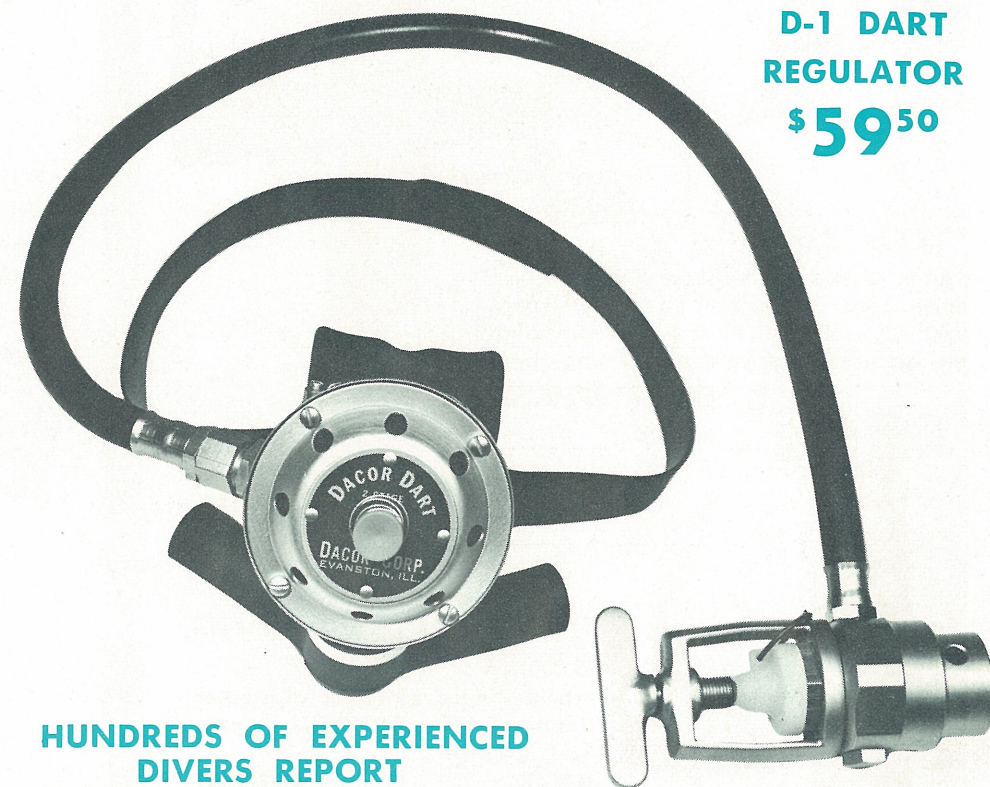

D-1 DART REGULATOR \$59⁵⁰

HUNDREDS OF EXPERIENCED DIVERS REPORT "IT'S A SWEETHEART"

NO COMPROMISE IN QUALITY OR FEATURES FOR PRICE

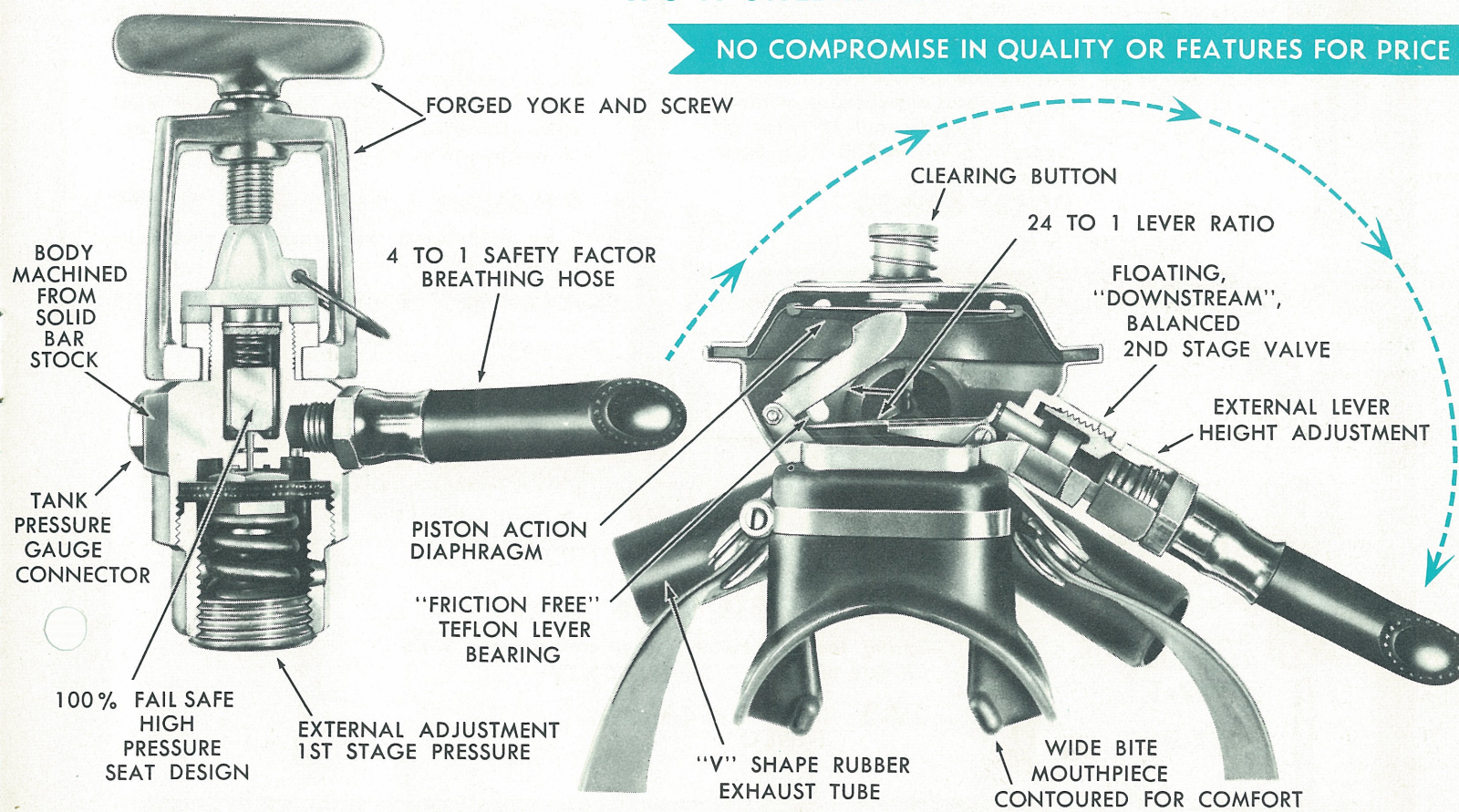

FORGED YOKE AND SCREW

BODY MACHINED FROM SOLID BAR STOCK

TANK PRESSURE GAUGE CONNECTOR

100% FAIL SAFE HIGH PRESSURE SEAT DESIGN

EXTERNAL ADJUSTMENT 1ST STAGE PRESSURE

4 TO 1 SAFETY FACTOR BREATHING HOSE

PISTON ACTION DIAPHRAGM

"FRICTION FREE" TEFLON BEARING

CLEARING BUTTON

24 TO 1 LEVER RATIO

FLOATING, "DOWNSTREAM", BALANCED 2ND STAGE VALVE

EXTERNAL LEVER HEIGHT ADJUSTMENT

"V" SHAPE RUBBER EXHAUST TUBE

WIDE BITE MOUTHPIECE CONTOURED FOR COMFORT



DACOR

One Line...

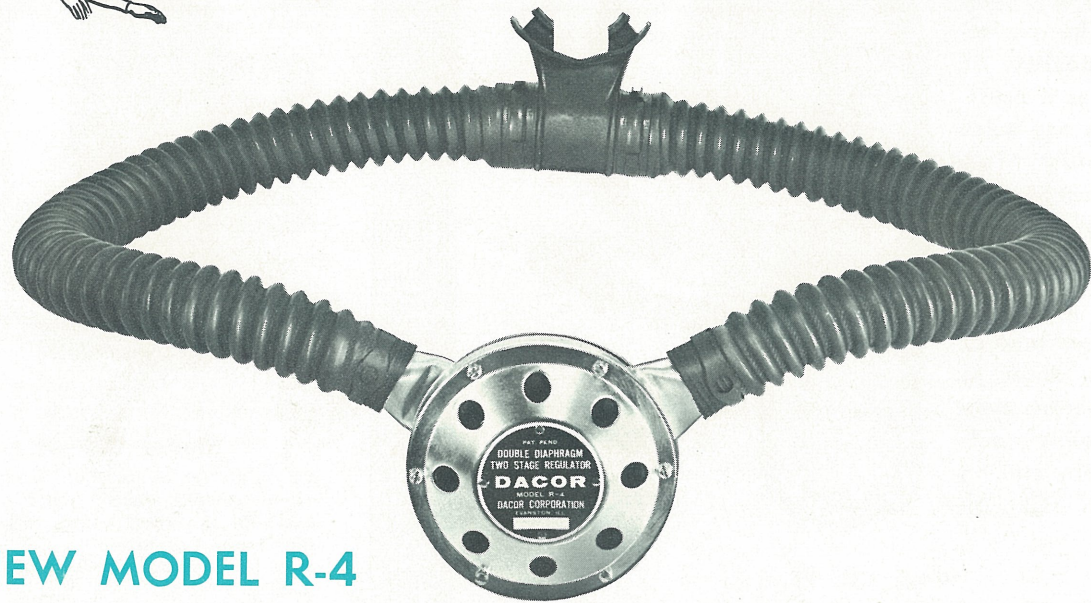

NEW MODEL R-4

"DIAL-A-BREATH" REGULATOR \$79.50

The New Model R-4 regulator is another Dacor achievement. The double diaphragm two stage regulator announced by Dacor nearly eight years ago offered a new concept in smoothness and ease of breathing, and was the first regulator ever offered with non return valves and offset mouthpiece design as regular equipment.

Now a new second stage design, similar in principle to the one used in our Dacor Dart single hose regulator, offers perfection in breathing never before achieved.

Other Exclusive Features:—

Double diaphragm for double safety and greater performance (Either diaphragm could become damaged and the regulator would continue to operate safely)

MOUTHPIECE UNMATCHED FOR COMFORT AND EFFICIENCY

"DIAL-A-BREATH"—Permits adjustment to any degree of easy breathing desired.

Balanced Breathing—(Double diaphragm operation provides the same effortless breathing on both inhale and exhale).

Breathing diaphragm does not come in contact with water and surrounding water pressure has no influence on the uniform operation of this diaphragm regardless of depth or position of Diver in water—(used by Divers at both North and South Poles and proven efficiency in tests to 83° below Zero).

Service Free Operation—(Requires less service in hard use than any regulator ever produced—Proven by Rental Shops and Repair Stations the world over).

Many owners report they get up to 20% more diving time on a tank of air with their Dacor regulator. It is the most expensive regulator to manufacture and will prove to be the most economical to own.

NO COMPROMISE IN QUALITY OR FEATURES FOR PRICE

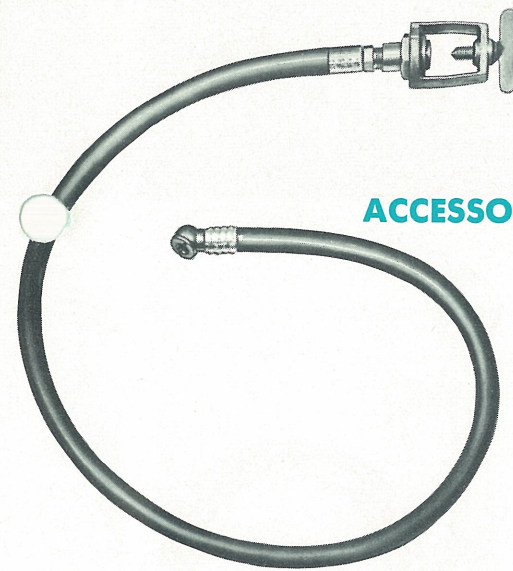
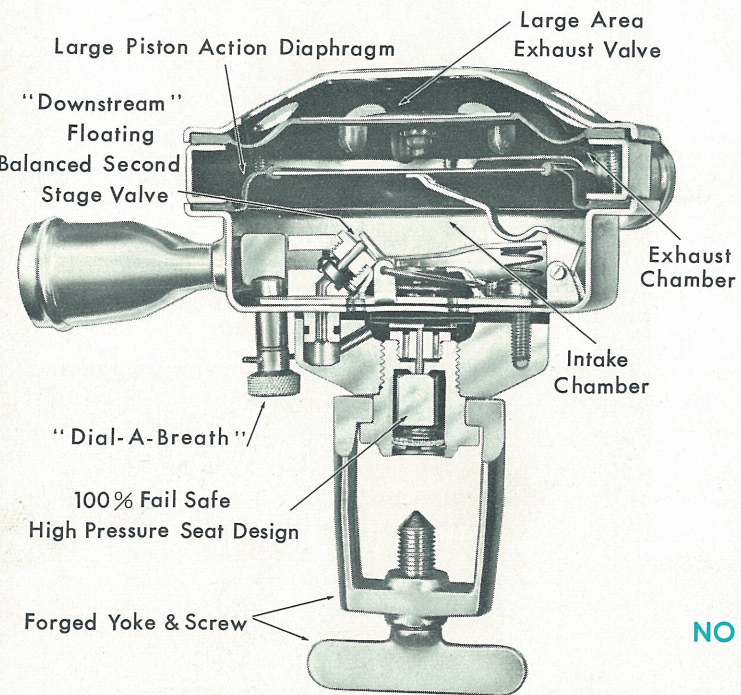

ACCESSORY INFLATOR

Built-in restricted orifice to reduce air volume for slower inflation provides safety. For use in filling auto tires, inner tubes and other inflatable items. Attach to diving cylinder valve for inflation needs.

\$7.95

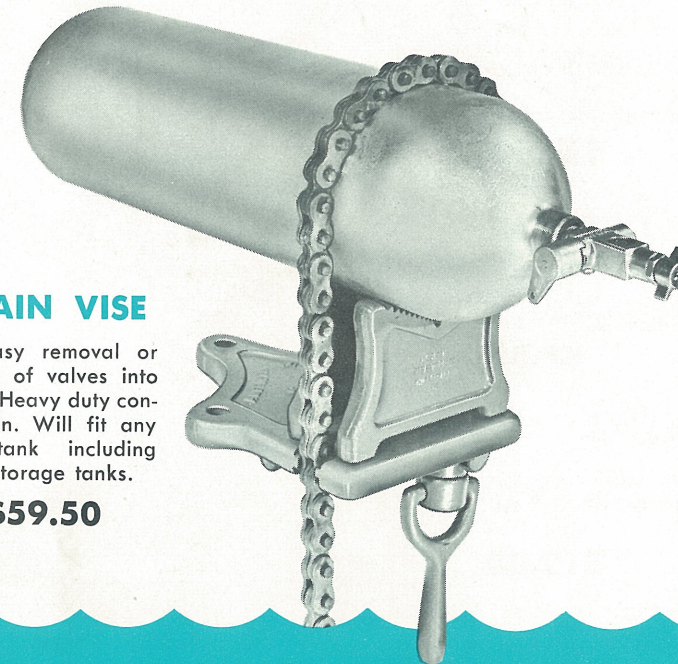

CHAIN VISE

For easy removal or sinking of valves into tanks. Heavy duty construction. Will fit any size tank including large storage tanks.

\$59.50

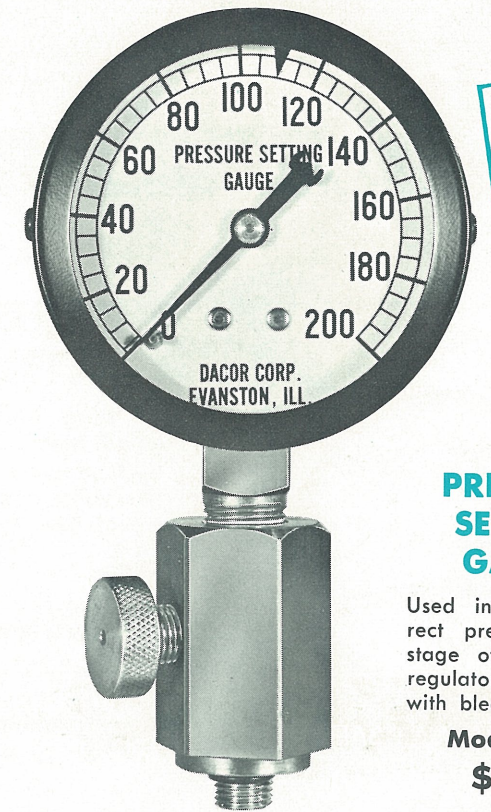

PRESSURE SETTING GAUGE

Used in setting correct pressure in 1st stage of single hose regulators. Complete with bleeder screw.

Model PSG \$9.95

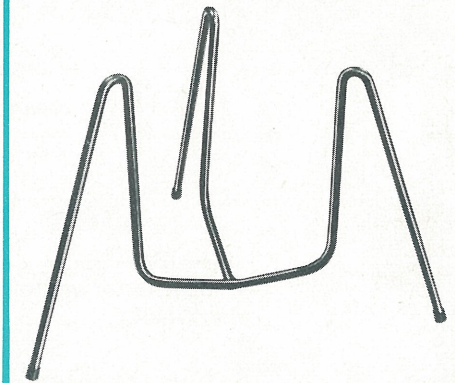

TANK STAND

Bright chrome plated. Excellent for keeping tank in upright position, either for display or storage.

Model DS-1 \$3.95



DACOR WATCHES

17 Jewel, Swiss movement. Stainless steel case. Pressure tested to 660 feet; rotating Bezel; luminous markings; non-irritating plastic strap. Anti-magnetic with one year guarantee.

- LW600—LADY DACOR** Small compact size for the girl diver . . . \$45.00 (Plus F.E.T.)
- UW600—Hand wound** . . . \$45.00 (Plus F.E.T.)
- AC600** Automatic self-winding with calendar indicator \$69.50 (Plus F.E.T.)

DEPTH GAUGE "THIN LINE"

Now the perfect depth gauge — low height, compact, brass case, chrome plated. Accurate within 2%, all depths. Luminous dial — 100 ft. — 200 ft. models. Protected by one piece molded rubber case and strap. Fully guaranteed. Widely accepted because of thin design, appearance and comfort.

Models DGR-100 and DGR-200 \$10.95 each



NO COMPROMISE IN QUALITY OR FEATURES FOR PRICE

DACOR Accessories and Fittings

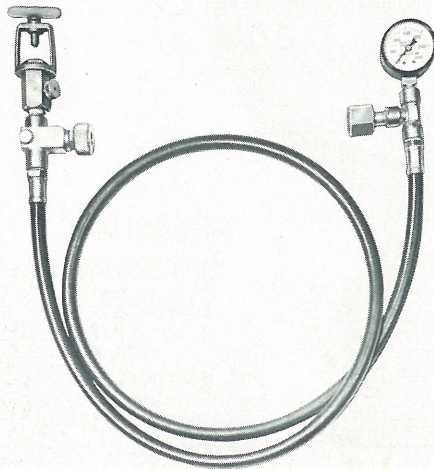

DELUXE FILLING ATTACHMENT

All brass high pressure fittings. 6 ft. length high pressure hose with minimum burst pressure of 11,000 P.S.I. Includes line valve and relief valve for easy removal from tank.

\$34.50

STANDARD FILLING ATTACHMENT

Same as above, but without line valve.

\$22.50

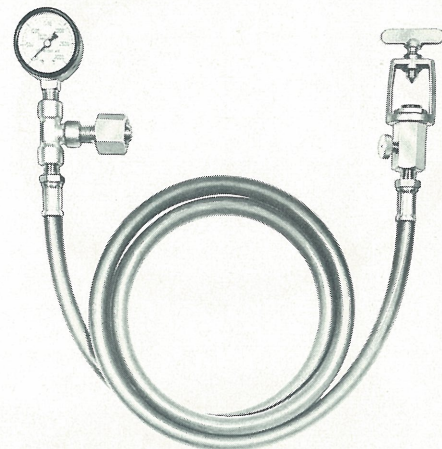

STORAGE TANK VALVE

Forged brass construction— $\frac{3}{4}$ " thread.

\$7.50

LINE VALVE

Exclusive Dacor design. Soft seat for fingertip on and off control. 3500 P.S.I. $\frac{1}{4}$ " N.P.T.

\$12.00

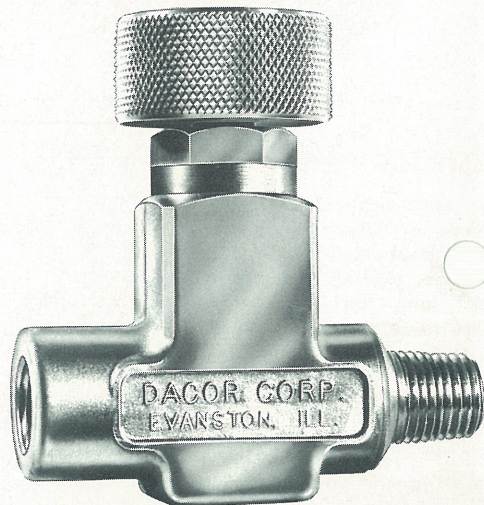
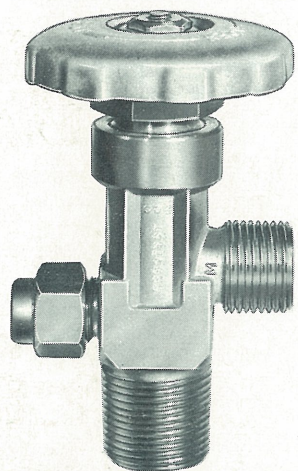

TANK BLOCKS COMPLETE

The Custom D-Pak assembly has two bands which holds tank more securely. The perfect contour design of D-Pak makes it possible to have one quick release only (Top Band) for fast removal of assembly.

When top band is drawn to a locking position upper area of Pak moves closer to tank and bottom area moves slightly outward, thereby making both bands tight on tank.



EXCLUSIVE DESIGN By DACOR

71.2 CU. FT.

Model TK-1 With Standard Valve **\$62.50**

Model TR-1 With Reserve Valve **\$82.50**

THE FAVORITE OF DIVERS

CUSTOM D-PAK

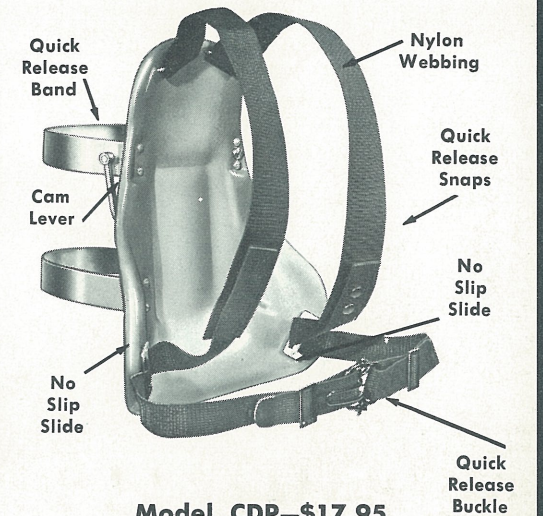

Model CDP—**\$17.95**

Adjustable for all sizes of diving tanks—Black nylon webbing—Heavy gauge aluminum back pak with two coats baked enamel finish over zinc chromate primer—"No Slip" slides prevents tank from moving when waist strap is unfastened.

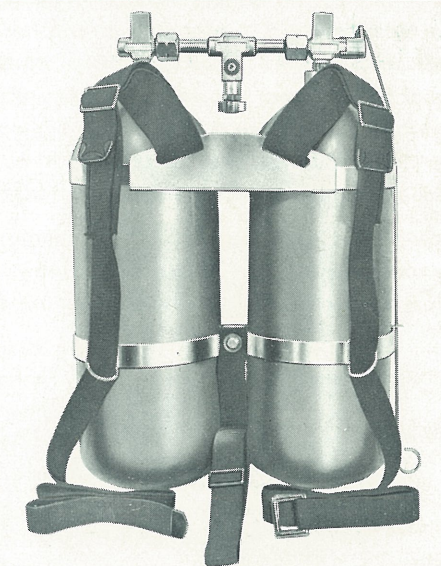

DOUBLE 42 CU. FT. Tanks
Model TR-42-2 With Reserve Valve **\$125.00**

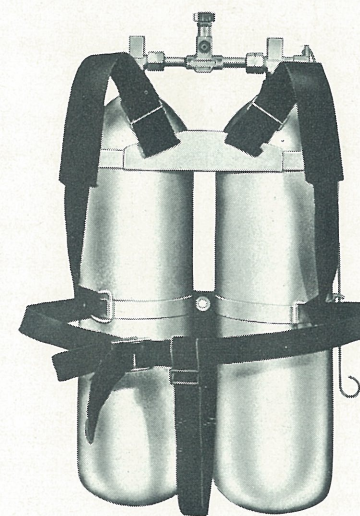

DOUBLE 71.2 CU. FT. Tanks
Model TR-2 With Reserve Valve **\$147.50**

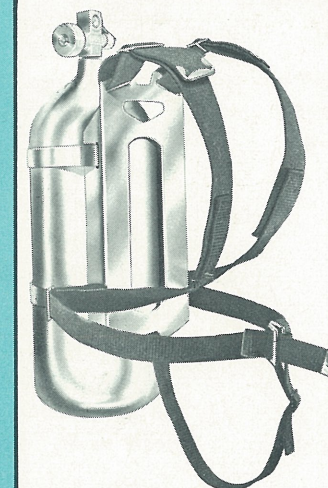

42 CU. FT. Tank
Model TK-42 With Standard Valve **\$55.00**
Model TR-42 With Reserve Valve **\$65.00**

All tanks galvanized — Available in colors, Black — Yellow — Blue (Two coats baked epoxy over galvanizing) At additional price of \$3.00 per tank.

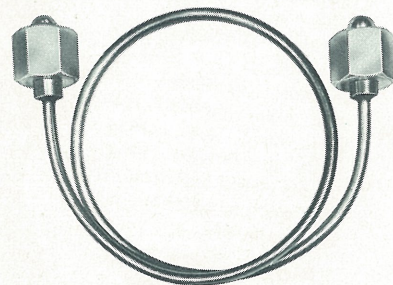

PIGTAIL CONNECTOR

For connecting storage tank tee and tanks.

\$4.95

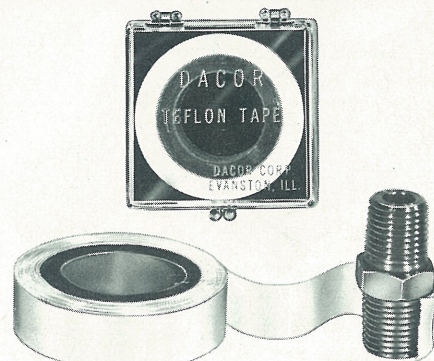

TEFLON TAPE (Roll $\frac{1}{2}$ " x 288")

Thread sealing material. Replaces paste type lubricants.

\$4.35

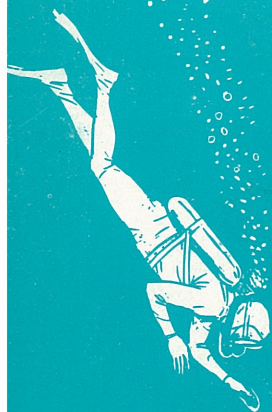

NO COMPROMISE IN QUALITY OR FEATURES FOR PRICE

NO COMPROMISE IN QUALITY OR FEATURES FOR PRICE

SURE PROOF TESTS

ALL DACOR FITTINGS ARE MACHINED FROM SOLID BRASS BAR STOCK AND ALL VALVES ARE FORGED BRASS WITH WORKING PRESSURES OF 3500 P.S.I.

"COLD ROOM"

On October 27, 1956, the Dacor double diaphragm, two stage regulator was tested at a temperature of 83 degrees below zero in the "Cold Room" of Perfection Division of Hupp Corporation, Cleveland, Ohio. It required nearly 10 days to get temperature in room down to minus 83 degrees.

The purpose was to test all materials used in the regulator and to determine whether it would operate safely under extreme freezing conditions. Even after pouring water over regulators which immediately froze, the regulators continued to supply air from the tanks.

Divers D. L. Davison and S. M. Davison Jr., Dacor Vice Presidents, performed the tests under supervision of two Perfection Company Research Engineers. Here they are shown being assisted in removal of equipment after leaving Cold Room. Complete story "Divers Deep Freeze" was published in Skin Diver Magazine February, 1957. The Dacor double diaphragm regulator does not permit water to come in contact with the breathing diaphragm and is therefore not prone to "Freeze-Up". The new Model R-4 regulator will perform with same efficiency.

- A - MANIFOLD - Application for multiple tank fillings 1 1/8" hex with 6 1/4" N.P.T. outlets...\$7.80
- B - MANIFOLD TEE - For connecting storage tanks together...\$4.95
- C - TANK THREAD REDUCER - 1" to 1/2"...\$3.55
- D - COUPLING - 1/4" N.P.T.\$2.45
- E - NUT AND TAILPIECE - For storage tank valve - 1/4" N.P.T.\$2.95
- F - CHECK VALVE - 1/4" N.P.T.\$5.75
- G - STREET ELBOW - Male and female threads - 1/4" N.P.T.\$1.45
- H - YOKE NIPPLE AND NUT - 1/4" N.P.T.\$1.50
- I - HEX NIPPLE - 1/4" N.P.T.\$2.00
- J - ELBOW - 1/4" N.P.T...\$2.25
- K - PLUG - 1/4" N.P.T...\$.45
- L - TEE - 1/4" N.P.T.\$3.20

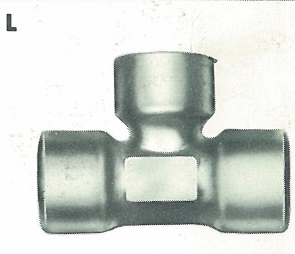
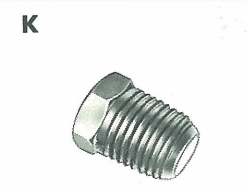
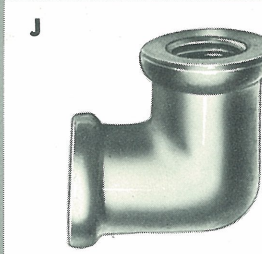
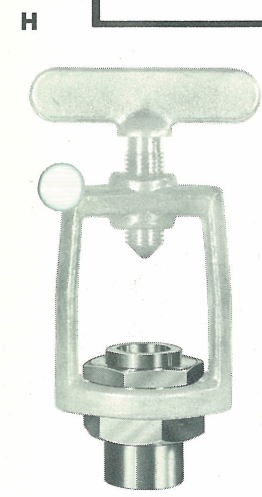
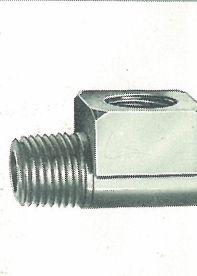
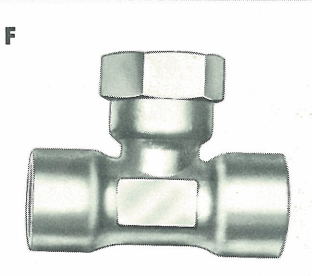
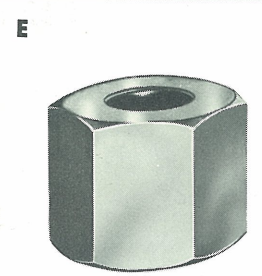
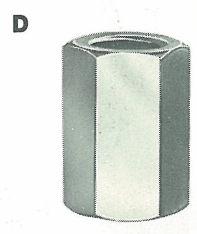
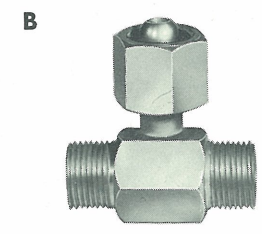
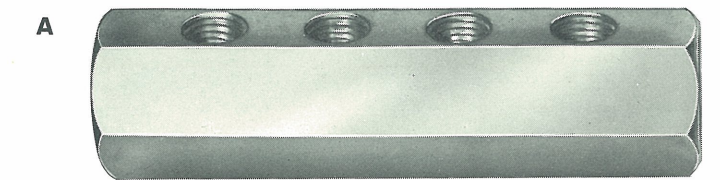

7000 FT. TEST

To test the Dacor Dart single hose, two stage regulator to a depth far greater than man's present ability to descend with a diving lung, Dacor designed, engineered and made a high pressure vessel containing a specially designed breathing mechanism to breathe from the regulator.

The regulator was operated at a simulated depth of 7000 ft. with perfect results.

This is one of many tests made with the Dart regulator which guarantees safety and service free operation for Divers.

S. M. Davison Jr., Dacor Vice President, demonstrates procedures of 7000 ft. test to a distinguished group.

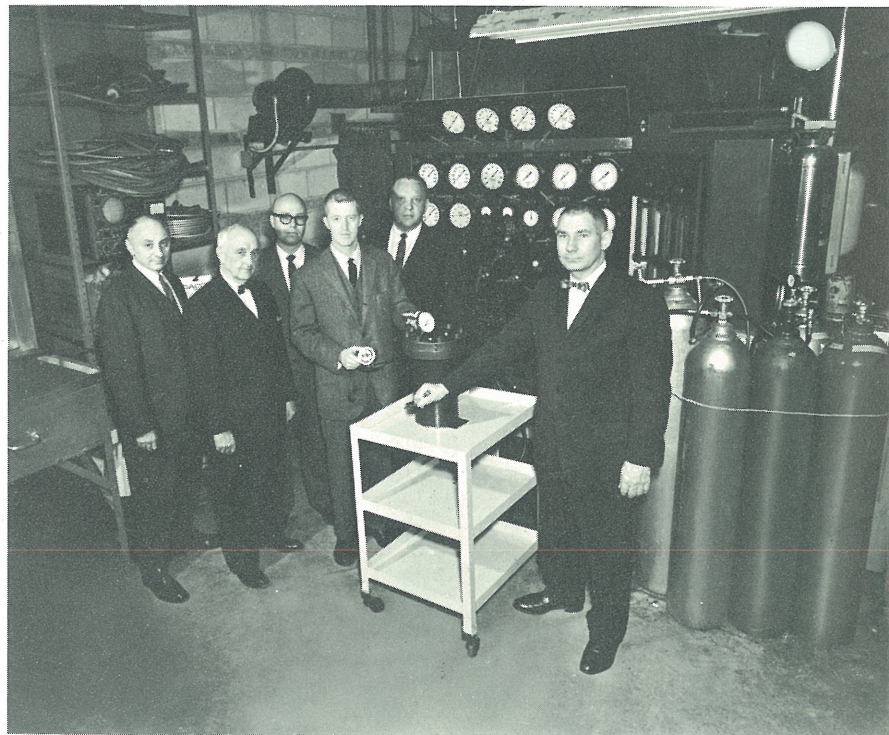

DACOR DIVING EQUIPMENT has always been tested under the most severe conditions possible. Dacor lungs were used in the cold waters at both North and South Poles. One State Trooper Detail has used more than 200 Dacor lungs over the past four years with a total maintenance and service cost of less than \$25.00. Many other similar reports are proof that "Service Free Operation" is unequalled. Dacor lungs are used by various departments of City, County, State, Federal Governments, and Armed Forces the world over.

For safety, quality, performance and service free operation — Dacor Equipment has no equal.

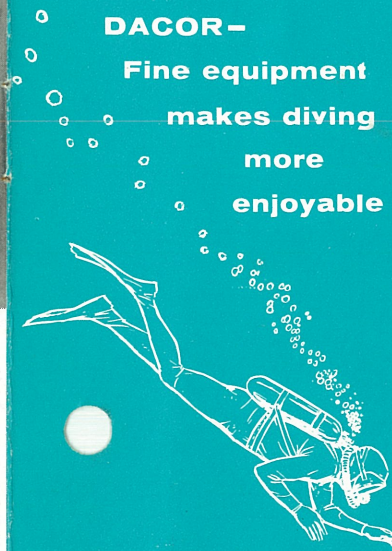

FOR USE IN AIR FILTER SYSTEMS

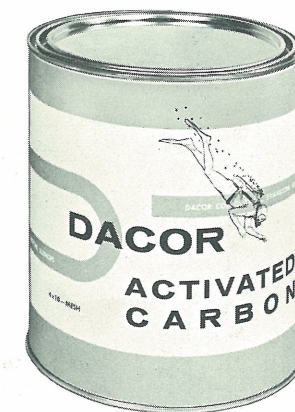

(Left)
1 Gal.
ACTIVATED
CARBON
(charcoal)
4 x 10 Mesh
\$4.75

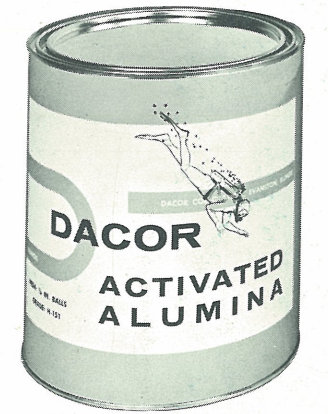

(Right)
1 Gal.
ACTIVATED
ALUMINA
\$9.15

Cover photo by DACOR taken at Weeki Wachee Springs, Fla.

DACOR PRODUCTS FEATURED ON COLORFUL MERCHANDISING DISPLAY CENTERS
WILL BE EXHIBITED BY LEADING RETAILERS EVERYWHERE
— BETTER PRODUCTS OF THE FUTURE WILL ALSO BEAR THE NAME DACOR —

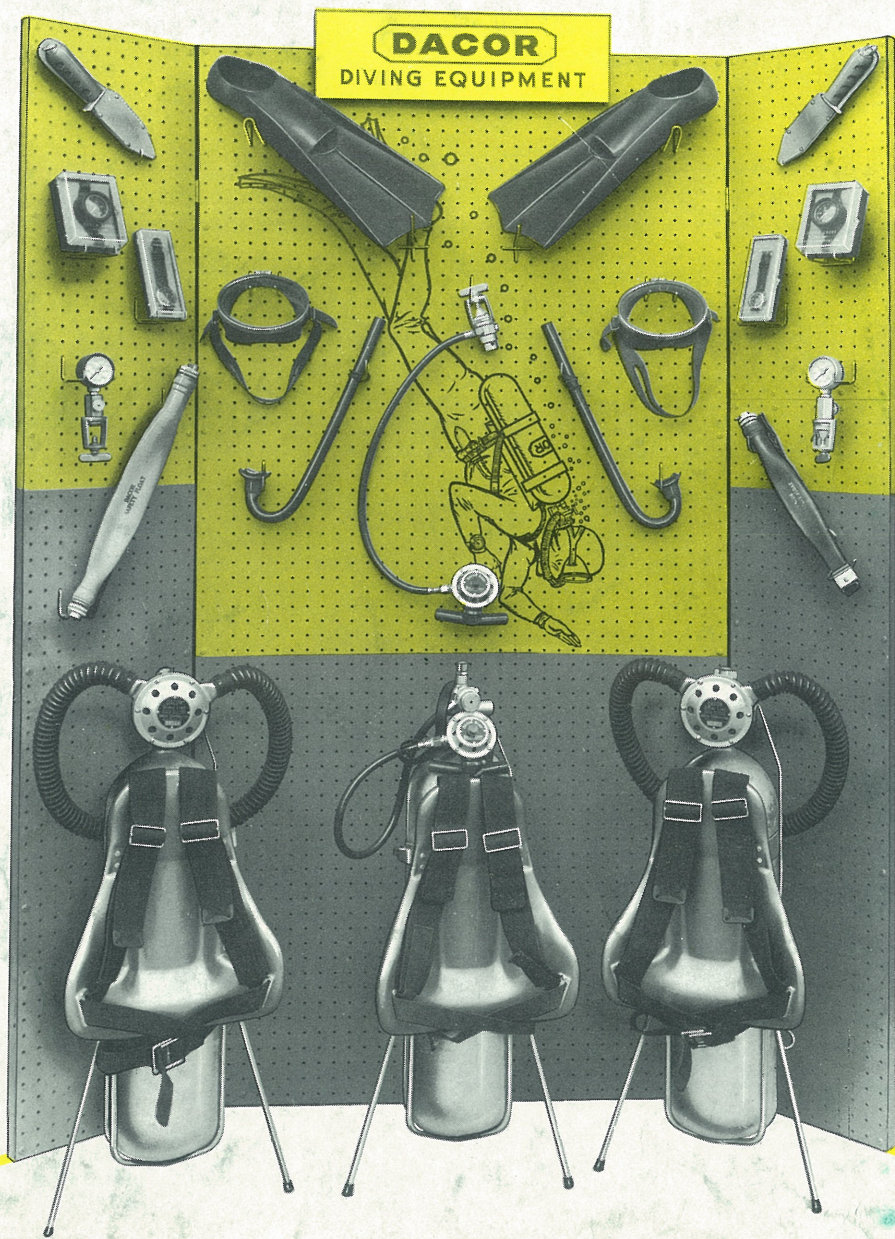

DACOR CORPORATION • P.O. BOX 551 • EVANSTON, ILL.



D A C O R

*Fine equipment makes
diving more enjoyable*

